



BN361

Benefit Enrollment and Maintenance

Instructor Led Training



Welcome to Cardinal Training

This training provides participants with the skills and information necessary to use Cardinal and is not intended to replace existing Commonwealth and/or agency policies.

The following HCM training materials are located on the Cardinal website (www.cardinalproject.virginia.gov) under Learning:

- Job Aids on topics across all functional areas
- Functional process and instructional videos

The Cardinal HCM Reports Catalogs are located on the Cardinal website under Resources.

The system screenshots included in the Cardinal HCM training courses show system pages and processes that some users may not have access to due to security roles and/or how specific responsibilities relate to the overall transaction or process being discussed.

- For a list of available roles and descriptions, see the Statewide Security Handbook on the Cardinal website in the Security section under Resources.



Course Objectives

After completing this course, you will be able to:

- 1 Understand Cardinal and the Benefits Functional Area
- 2 Know the Key Concepts related to Benefit Events and Programs
- 3 Know how to navigate within the Cardinal Benefits Functional Area
- 4 Know how process New Hire Enrollments and Transfers
- 5 Know how to process Manual Benefit Events (Life Events, Open Enrollment, QMCSO, etc.)
- 6 Know how to view Employee and Dependent Benefits information



Course Objectives (continued)

- Know how to administer COBRA
- Know how to complete Health Benefits Reconciliation
- Understand how to administer Affordable Care Act (ACA) reconciliation
- Understand how to process Retirement Plan Enrollments
- Understand how to process ORP and VRS Retirements
- Understand how to complete VRS Billing Reconciliation



Agenda

1

Cardinal and Benefits Overview

2

Key Concepts: Benefit Events and Programs

3

Benefits Navigation Overview

4

Processing New Hire Enrollments and Transfers

5

Processing Manual Benefit Events

6

Viewing Other Employee and Dependent Benefits Information



Agenda

7

COBRA Administration

8

Health Benefits Reconciliation

9

Affordable Care Act (ACA) Administration

10

Retirement Plan Enrollments

11

Processing Retirements Overview



Lesson

1

Cardinal and Benefits Overview

This lesson covers the following topics:

- Overview of Cardinal
- Cardinal HCM Responsibilities and Relationships
- Overview of the Benefits Functionality



Cardinal Overview

Cardinal provides better access to essential business functions and improved single sign-on technology.

The Cardinal system is comprised of three applications: Human Capital Management (HCM), Financials (FIN), and Business Intelligence (BI).





Cardinal Human Capital Management (HCM)

In Cardinal HCM, HR Administrators, BN Administrators, TL Administrators, Payroll Administrators, and State Payroll Operations (SPO) work together so that all employees are paid on time and accurately and are benefited properly.

All these roles and their unique responsibilities flow to one another in order to ensure that all employee records are accurate and up-to-date.

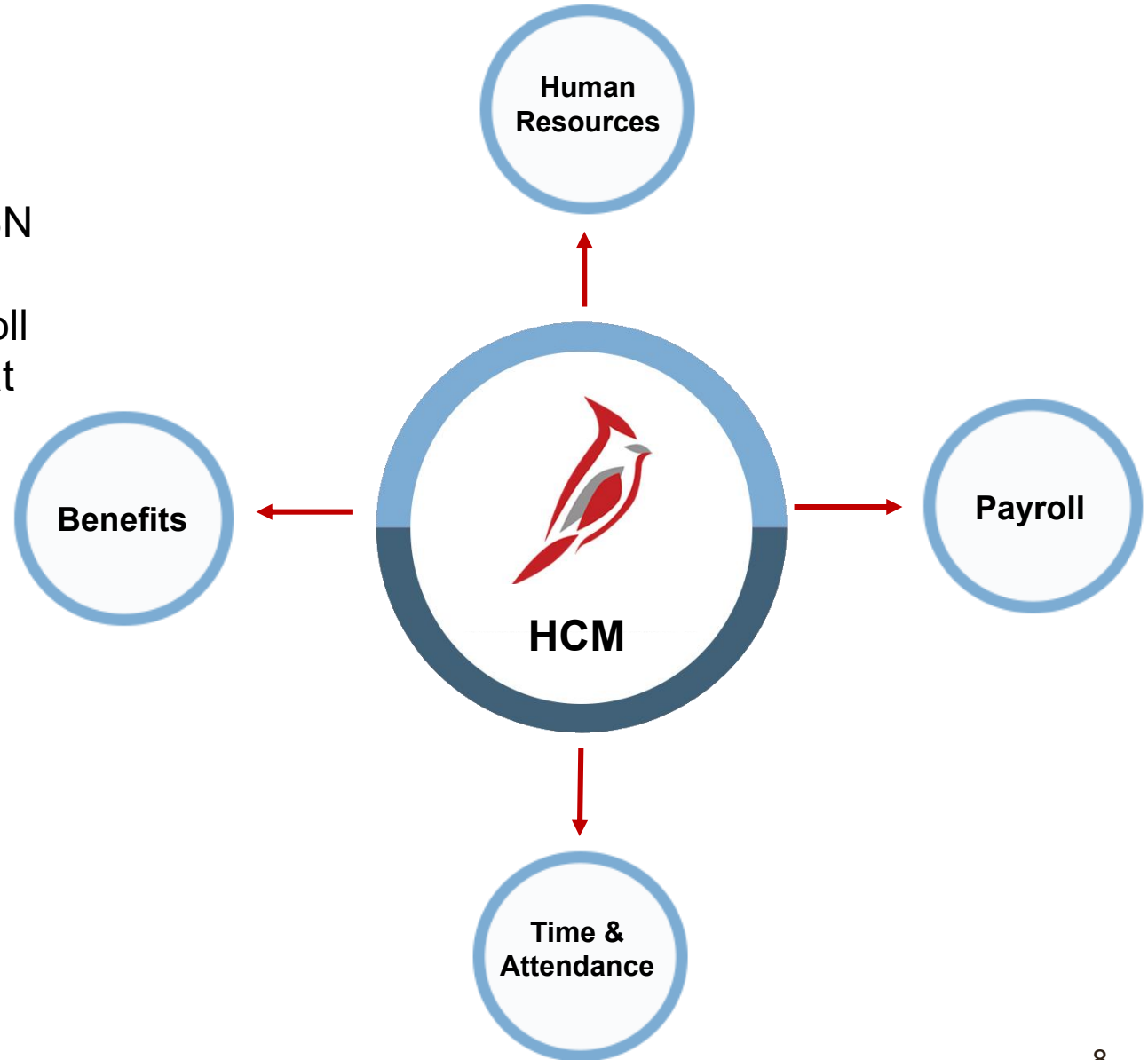



Cardinal HCM Responsibilities and Relationships

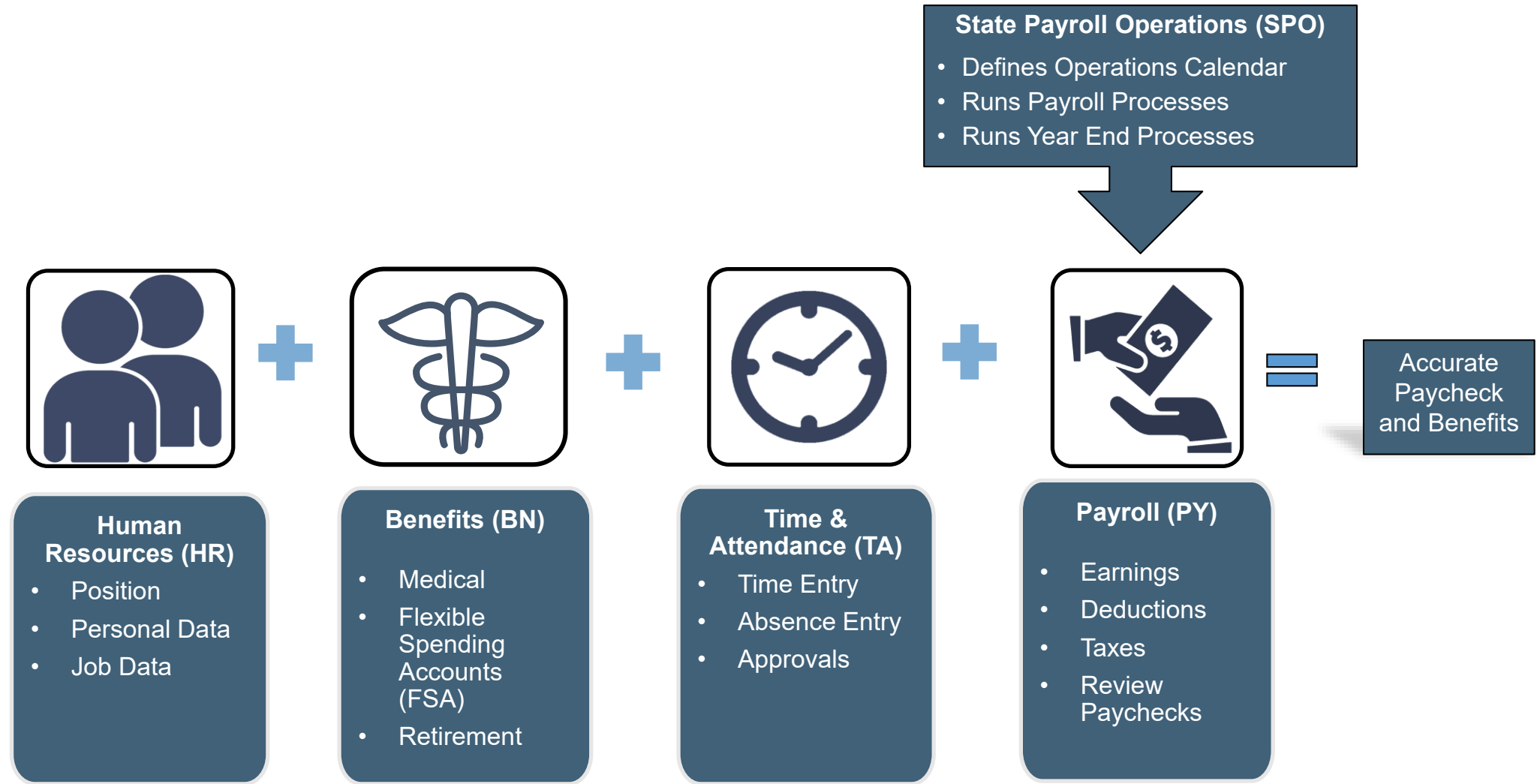



Overview of the Benefits Functionality

The Benefits functional area includes all processes and sub-processes required for maintaining benefits for the organization's employees and their dependents.

The Benefits processes and sub-processes are:



Maintain Enrollments for:

- Benefit Events
- Life Event
- QMCSO
- Retirement
- Deferred Compensation
- Annuity
- Health Reconciliation
- VRS Billing Reconciliation



Lesson Summary

1

Cardinal and Benefits Overview

In this lesson, you learned:

- An Overview of Cardinal
- About the Cardinal HCM Responsibilities and Relationships
- An Overview of the Benefits Functionality



Lesson

2

Key Concepts: Benefit Events and Programs

This lesson covers the following topics:

- Key Concepts pertaining to:
 - Benefit Events
 - Lifecycle of a Benefit Event



Benefit Events

Benefit Events evaluate or reevaluate an employee's benefit eligibility and provide the employee with the opportunity to update their enrollment as needed.

All benefit enrollments or changes are made through a Benefit Event. The types of Benefit Events include:

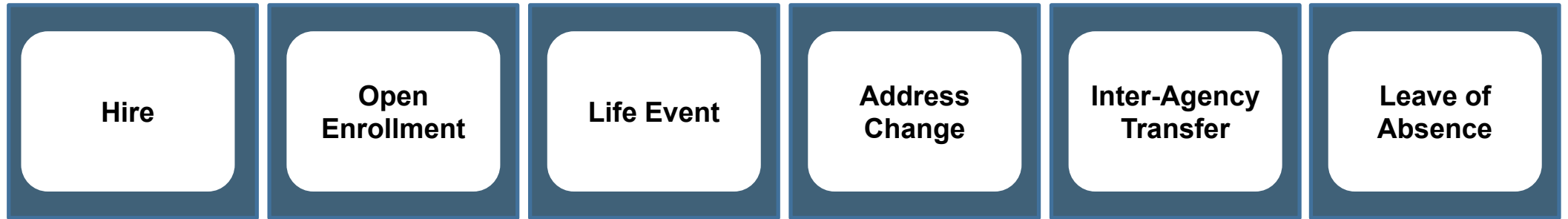

Only one Benefit Event can be open at any time. It is extremely important that open events are monitored and processed as soon as possible.



Lifecycle of a Benefit Event

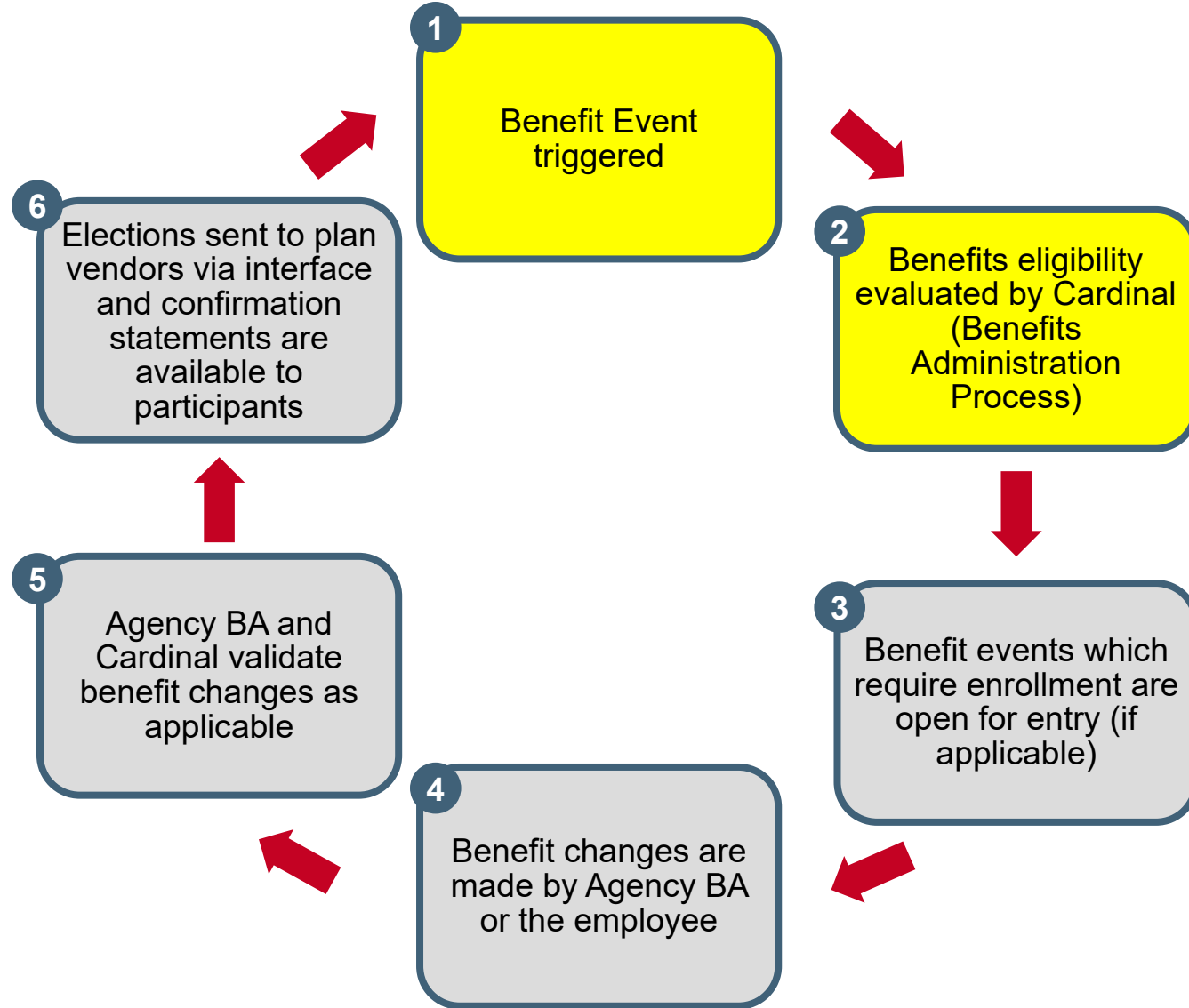



Benefit Events Triggers

Benefit Events can be triggered in three different ways:

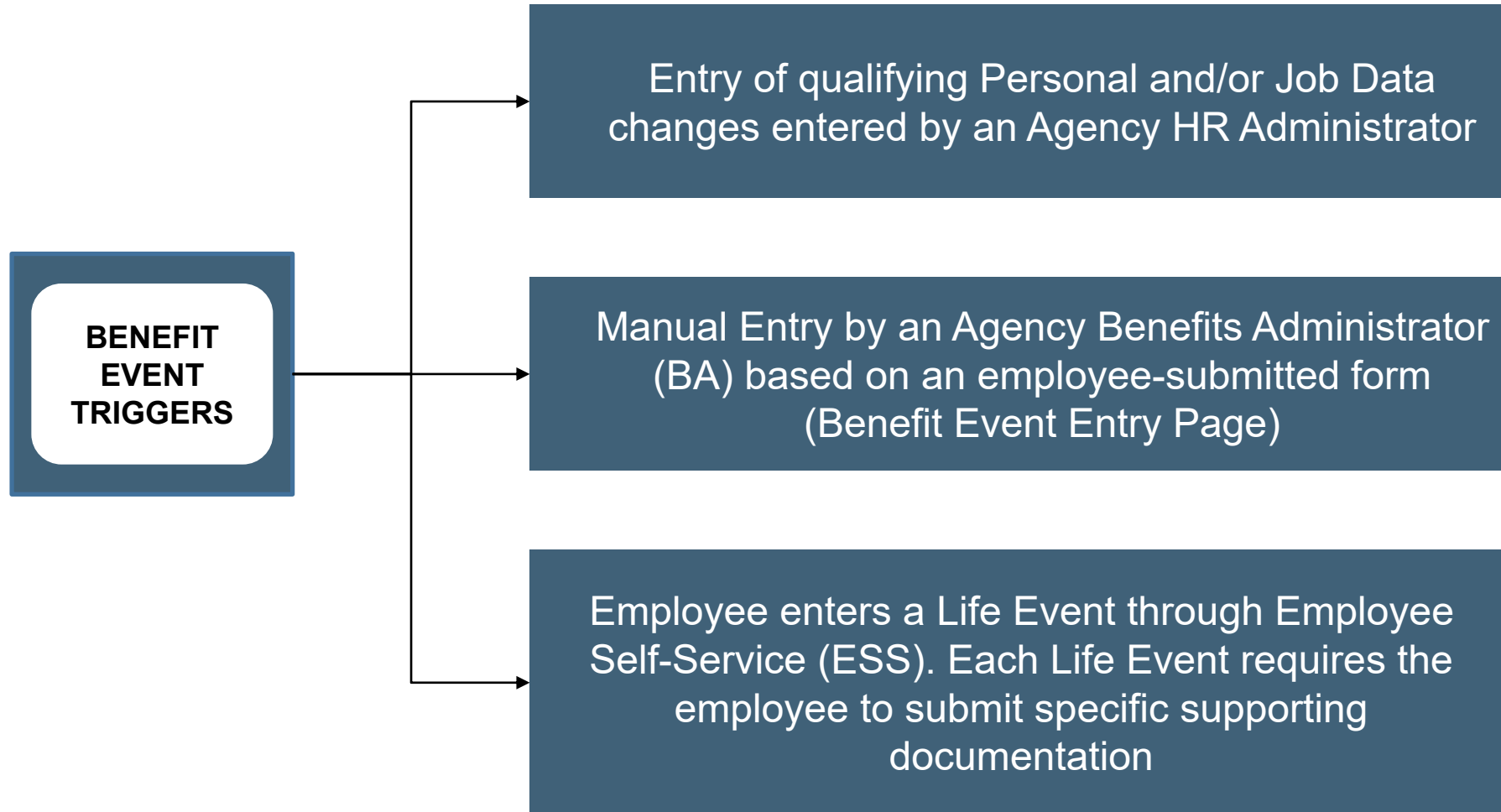



Eligibility Determination (Benefits Administration Process)

Most Job Data changes will trigger a Benefit Event. All Benefit Events are evaluated by the Benefit Administration process. However, many are immediately closed because no benefits eligibility change exists (e.g., supervisor change).

Changes that would make the employee eligible to update their benefits include the following:

JOB DATA

- Action / Reason
- Employee Class
- Part / Full / Quasi Status
- Pay Frequency
- Work Location
- Eligibility Configuration Fields

PERSONAL DATA

- Date of Birth
- Gender
- Marital Status
- Address (Zip Code)

Note: The Benefits Administration Process nightly.



Lifecycle of a Benefit Event (continued.)

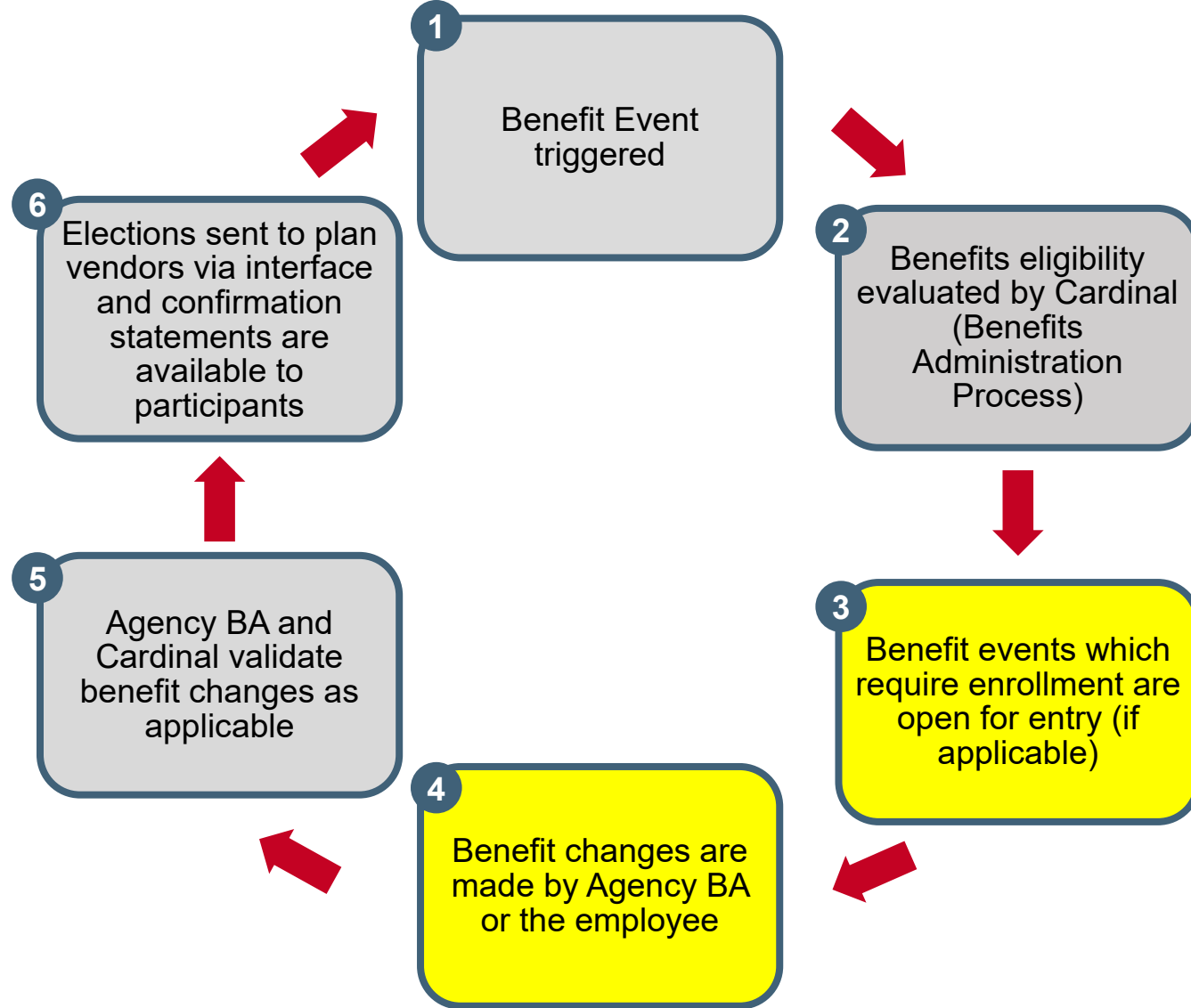



Benefit Program Selection Example

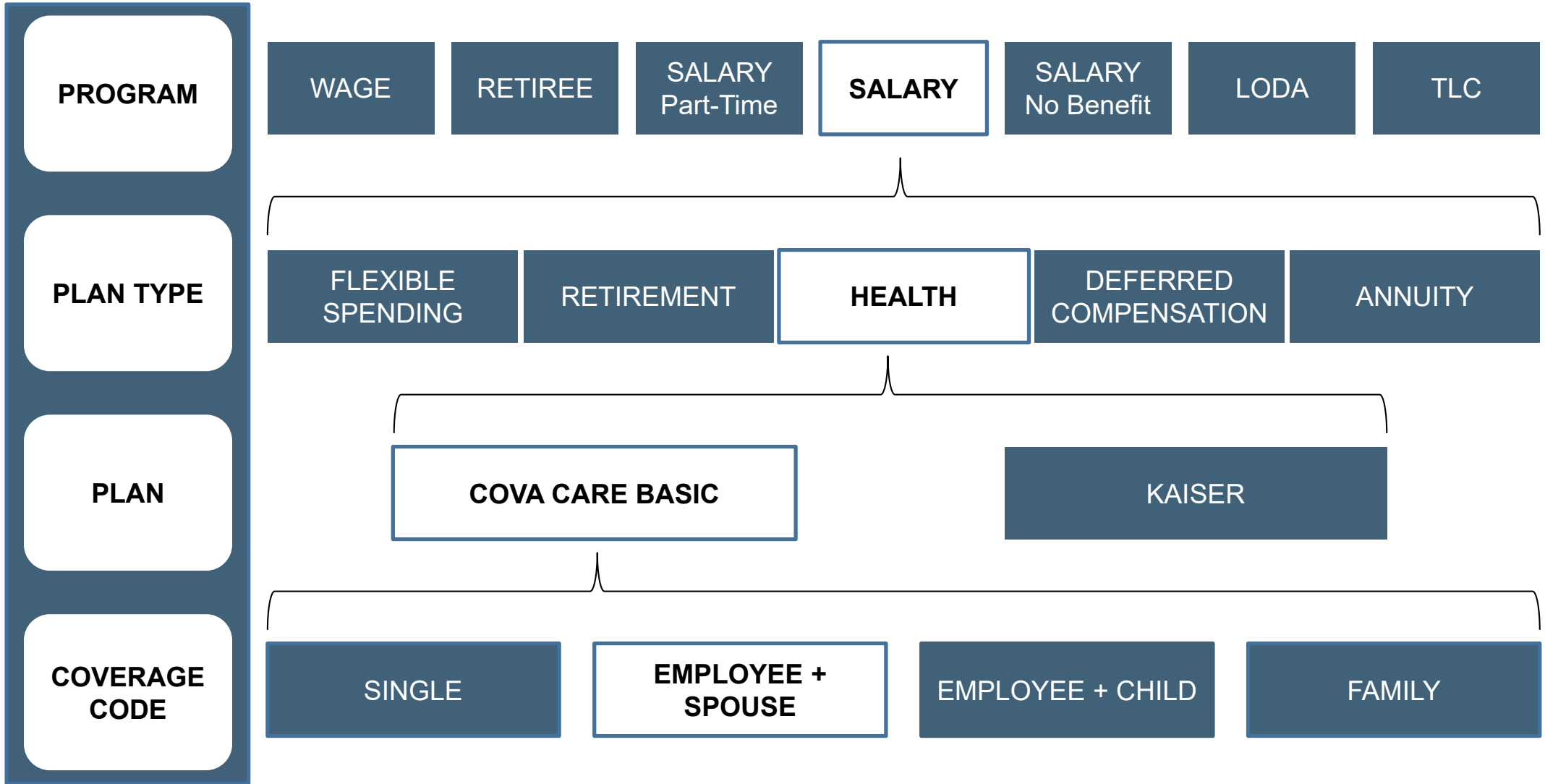

Note: For further information and a complete list of Benefits Plans, refer to the Job Aid titled **BN361 Quick Reference Guide**.¹⁸ This Job Aid can be found on the Cardinal website in **Job Aids** under **Learning**.



Lifecycle of a Benefit Event (continued..)

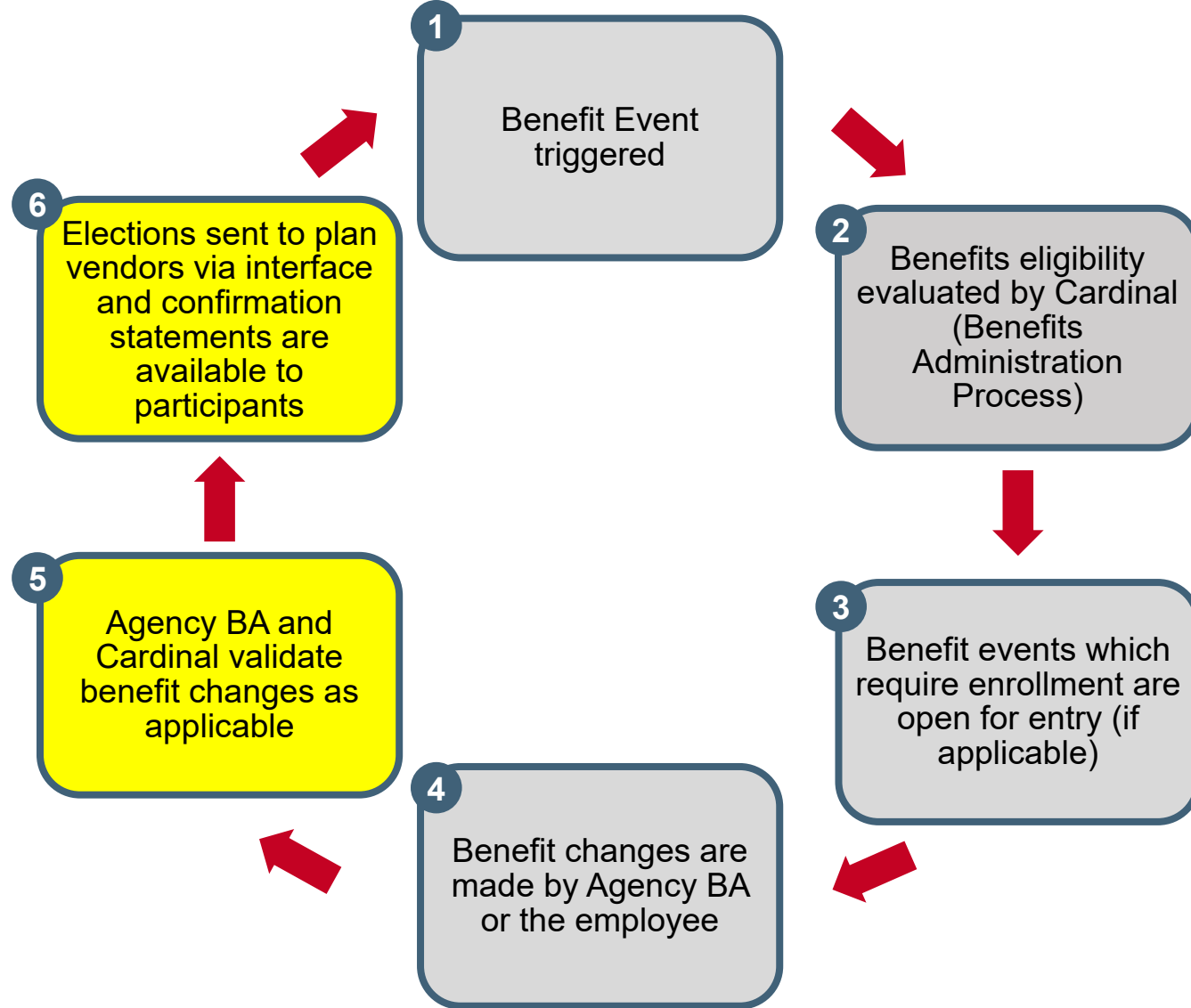



Lesson Summary

2

Key Concepts: Benefit Events and Programs

In this lesson, you learned

- The Key Concepts pertaining to:
 - Benefit Events
 - Benefit Event Triggers
 - Lifecycle of a Benefit Event



Lesson

3

Benefits Navigation Overview

This lesson covers the following topics:

- Benefits Navigation Overview
- Overview of the Benefits Administrator Page Menu
- Accessing the On-Demand Maintenance Page
- Overview of the On-Demand Maintenance Page



Benefits Navigation Overview

Accessing the various Benefits pages, reports, and queries is completed through both:

- **Benefits Administrator** tile
- **NavBar > Menu > Benefits**

The screenshot displays the Cardinal Non-Production system interface. The main content area features several tiles: 'Cardinal Message Board' (0 messages published today, 0 total active messages), 'Cardinal Portal', 'Benefits Administrator' (highlighted with a red box), and 'Benefit Details'. The 'Benefits Administrator' tile contains icons for a person, a wallet, a medical cross, and a house. On the right side, the 'NavBar: Menu' is visible, listing various options under the 'Benefits' section, including 'Employee/Dependent Information', 'Review Employee Benefits', 'Enroll In Benefits', 'Manage Automated Enrollment', 'Maintain Primary Jobs', 'Reports', 'Interface with Providers', 'Monitor Savings Plan Extensions', 'Administer COBRA Benefits', 'ACA Annual Processing', 'Employer Information', 'Manage Life Event Instance', and 'Clone TLC Data Sheet'. The 'Menu' option in the NavBar is also highlighted with a red box.



Benefits Administrator Page Menu Overview

The **Benefits Administrator Page Menu** is used to access most of the Benefits pages that are utilized to:

- Update/View Employee and Dependent information
- Perform Benefit Enrollments
- Review Employee Benefits information
- Process Benefit Events

The screenshot displays the 'Benefits Administrator' interface. On the left, a sidebar menu is visible with the following items: 'Cardinal Homepage', 'Employee/Dependent Information' (expanded), 'Update Dependent/Beneficiary' (highlighted in green), 'Maintain Certifications', 'Enroll in Benefits', 'Review Employee Benefits', and 'Benefits Management'. The main content area is titled 'Update Dependent/Beneficiary' and includes the instruction: 'Enter any information you have and click Search. Leave fields blank for a list of all values.' Below this is a 'Find an Existing Value' button. The 'Search Criteria' section contains several search fields: 'Empl ID', 'Name', 'Last Name', 'Second Last Name', 'Alternate Character Name', and 'Middle Name', each with a 'begins with' dropdown and an input field. At the bottom, there are checkboxes for 'Include History', 'Correct History', and 'Case Sensitive', a text input for 'Limit the number of results to (up to 300):' with the value '300', and buttons for 'Search', 'Clear', 'Basic Search', and 'Save Search Criteria'.



On-Demand Event Maintenance Page Overview

The **On-Demand Event Maintenance** page allows the BA to perform maintenance to currently open and closed Benefits Events.

The screenshot shows the 'On-Demand Event Maintenance' page within the 'Benefits Administrator' interface. The page is divided into a left-hand navigation menu and a main content area. The navigation menu includes options like 'Employee/Dependent Information', 'Enroll in Benefits', 'Review Employee Benefits', 'Benefits Management', 'Online Confirmation Statements', 'FMLA', 'Review BAS Activity', 'On-Demand Event Maintenance' (highlighted), 'Review Processing Messages', 'Update Event Status', and 'Benefits Configuration'. The main content area is titled 'On-Demand Event Maintenance' and displays a form for managing an event. It includes fields for 'Person ID', 'Ben Record', 'Activity Date', 'Source', and 'Empl Record'. There are several buttons for actions such as 'Schedule/Prepare Activity', 'Show Activities', 'Event Status Update', 'Prepare Options', 'Enrollment Statement', 'Election Entry', 'Validate/Finalize', 'Confirmation Statement', 'Reprocess', 'Save', 'Return to Search', 'Previous in List', 'Next in List', and 'Notify'. A 'Frequency' section allows selecting between 'Deduction Frequency' (selected) and 'Annual Frequency'. A 'Process Indicator' is set to 'N' for 'Normal Processing'. The page also features a top navigation bar with 'Workforce Administrator' and 'Benefits Administrator' tabs, and a right-hand navigation bar with 'New Window', 'Help', and 'Personalize Page' options.

Note: See the Appendix for a list of Events Statuses, Event Process Statuses, and the Process Indicators.



Lesson Summary

3

Benefits Navigation Overview

In this lesson, you learned

- Benefits Navigation Overview
- Overview of the Benefits Administrator Page Menu
- Accessing the On-Demand Maintenance Page
- Overview of the On-Demand Maintenance Page



Lesson

4

Processing New Hire Enrollments and Transfers

This lesson covers the following topics:

- General Information about New Hire Enrollments
- Processing a New Hire Enrollment
- Viewing employee Benefits information (current)
- Re-opening and reprocessing Benefit Events
- Viewing employee Confirmation Statements
- Overview of the Inter-Agency Transfer Process



New Hires



New Hire Enrollments General Information

Reminder: All benefit enrollments or changes are made through a Benefit Event.

New Hire Benefit Events are triggered when an Agency Human Resources (HR) Administrator processes a “New Hire” action:

- **HR2:** This event will automatically enroll the eligible employee in the Imputed Life Insurance Income Plan after the Benefits Administration process runs. The Benefits Administration process runs nightly on a schedule. The event will automatically close after the Benefits Administration process runs. This event must be processed before completing the employee’s other enrollments via the HIR Benefit Event and can be processed manually as needed if the Benefits Administration process has not run
- **HIR:** This event is processed by an Agency BN Admin to complete the employee’s enrollment elections (Medical, FSA, etc.)

The Event Date for both events is driven based on the Effective Date of the “New Hire” action completed by HR.



New Hire Enrollments General Information (continued)

The Coverage Begin Date for the Imputed Life Insurance Income Plan will be the first day of the month in which the employee was hired

The Coverage Begin Date for all other elected plans will be the first day of the month following employee's hire date. (ex: employee hired on 10/25/2022, Coverage Begin Date for elected plans will be 11/1/2022)

The Deduction Begin Date for all elected plans will be the same as the coverage begin date for New Hire Benefit Events.

Plan elections are transmitted to the Vendor nightly (Monday – Friday excluding holidays).

Confirmation Statements will be available after the Benefits Administration process runs.



Finalizing Benefit Events Errors

The system performs validations when the **Validate/Finalize** button is clicked. These validations include:

- Validating dependent eligibility
- COVA systematic rules pertaining to valid elections/transactions

If any errors are identified, they will display as a numeric value (1, 2, 3, etc.) in the **Errors** field to the right of the **Validate/Finalize** button. The corrective action will vary based on the actual error received.

For further information on troubleshooting errors, refer to the Job Aid titled **BN361_Benefits Quick Reference Guide**. This Job Aid can be found on the Cardinal Website in **Job Aids** under [Learning](#).



Viewing an Employee's Benefits Enrollments Information

The Benefits enrollment information for an employee can be viewed on the following pages at any time. These page include current, historical, and future dated benefit enrollments for the employee. Therefore, review of these pages is recommended after any Benefit Event is processed to ensure accuracy (New Hire, Life Event, etc.):

Health Benefits page: Health Benefit enrollments

NavBar > Menu > Benefits > Enroll in Benefits > Health Benefits

Simple Benefits page: Premium Reward and Flex Spending Admin Fee enrollments

NavBar > Menu > Benefits > Enroll in Benefits > Simple Benefits

Life and AD/D Benefits page: Imputed Life Insurance Income Plan enrollment

NavBar > Menu > Benefits > Enroll in Benefits > Life and AD/D Benefits

Spending Accounts page: Flex Spending Medical Plan and Flex Spending Dependent Care Plan enrollments

NavBar > Menu > Benefits > Enroll in Benefits > Spending Accounts



Viewing an Employee's Benefits Enrollments Information (continued)

Pages continued:

Savings Plans page: Savings Plan enrollments

NavBar > Menu > Benefits > Enroll in Benefits > Savings Plans

Retirement Plans page: Retirement Plan enrollments

NavBar > Menu > Benefits > Enroll in Benefits > Retirement Plans



Viewing an Employee's Current Benefits Enrollments and Deductions

The current Benefits information for an employee can be viewed on the **Current Benefits Summary** page at any time. This page does not include any historical or future dated benefit elections data for the employee. As the elections are quite frequently effective on the first of the following month, this is not recommended as a means to ensure accuracy after any Benefit Event is processed (New Hire, Life Event, etc.). Navigate to the **Current Benefits Summary** page using the following path:

NavBar > Menu > Review Employee Benefits > Current Benefits Summary



Re-Opening a Benefit Event

If any updates/corrections need to be made after processing a Benefit Event, the Benefit Event can be re-opened for edits and then reprocessed. Benefit Events must also be re-opened once the applicable supporting documentation is received in order to update the dependent(s) from “Unapproved” to “Approved”.

Benefit Events are re-opened on the **BenAdmin Event Status Update** page. Navigate to this page using the following path:

On-Demand Event Maintenance page > Events Status Update button

BenAdmin Event Status Update

Update Event Status

Empl ID 00858056800 Thomas Jones30 Ben Record 0

Event Status Update ?

Schedule ID EM00 Event Disconnected

Event Date 10/25/2022

Event ID 1

Event Class HIR Initial Enrollment

Event Priority 100

Benefit Program SAL

Process Status Finalized - Enrolled

Action Source Job Data Change

Address Eligibility Changed

MultiJob Indicator Changed

Job Eligibility Changed

Event Out of Sequence

Finalize/Apply Defaults

Print Option Print Both Forms

*Process Re-Enter

*Event Status Open for Processing

OK Cancel Apply Refresh



Confirmation Statements General Information

The Agency BA can view and print Confirmation Statements. Each Benefit Event creates a new Confirmation Statement. When an employee performs Benefit Enrollments and/or submits a Life Event, the Agency BA can review the employee's Confirmation Statements.

- Confirmation Statements are created and run as batch jobs
- The Agency BA has access to view/print their employees' Confirmation Statements
- The Benefit Confirmation Statements list the participants' recent benefit elections and the per-pay-period costs
- The participant submits a marked-up Confirmation Statement to the Agency BA for review if any changes are required The Agency BA would update the enrollment to have a new statement generated
- Federally mandated health benefit notice language is included in the printed Confirmation Statements

Confirmation Statements are viewed/printed from the **Review Employee Statements** page. Navigate to this page using the following path:

Benefits Administrator tile > Review Employee Benefits > Review Employee Statements



Email Notification Sent to Employee

Benefits Confirmation Available ▷ Inbox x 🖨️ 🔗

 **PeopleSoft@peoplesoft.com**
to me ▼ Tue, Feb 4, 11:06 AM ☆ ↶ ⋮

This email is to confirm that the Benefits Department has confirmed your benefits enrollment. Your Benefits Confirmation Statement has been posted on the Employee Self Service website.

Employee ID:

[View Online Statement](#)

↶ Reply ➦ Forward



Inter-Agency Transfers



Processing Inter-Agency Transfers Overview

When employees transfer from one Commonwealth of Virginia Agency to another Commonwealth of Virginia Agency, this is known as an Inter-Agency Transfer. This process must be completed correctly in order to ensure that there is no break in service or interruption of benefits for the employee.

General Guidelines:

- There are two Agencies involved in this process; the Sending Agency (employee leaving from) and the Receiving Agency (employee going to)
- The two Agencies must coordinate the effective date for the HR transactions in order to ensure that there is no break in service or interruption of benefits for the employee (same effective date on both HR transactions)
- The Agency where the employee is employed on the first of the month is responsible for the entire month's employer paid premium



Sending Agency

No action is required by the Sending Agency BN Administrator.

The Sending Agency HR Administrator completes a “Termination: Transfer Out” transaction with an effective date equal to the date last worked at the Agency by the employee.

This transaction must be completed by the Sending Agency **before** the Receiving Agency HR Administrator processes the “Hire: Transfer In” transaction.

This transaction triggers an “XFO” Benefit Event. This Benefit Event will automatically process and close once the Benefits Administration process runs and completes the following:

- Carries over the eligible* employee’s Health Insurance, Premium Rewards, Imputed Life, and FSA enrollments with no gap
- Any Deferred Compensation, Annuity, and VRS Retirement Plans the employee is enrolled in will be terminated

* This is not applicable if the employee is transferring from one Agency as an hourly employee (no benefits) and transferring into an Agency with a salaried position (eligible for benefits)



Receiving Agency

The Receiving Agency HR Administrator completes a “Hire: Transfer In” transaction with an effective date equal to the date last worked at the previous Agency by the employee (to avoid break in service).

This transaction must be completed by the Receiving Agency **after** the Sending Agency HR Administrator processes the “Termination: Transfer Out” transaction.

This transaction triggers an “XFR” Benefit Event. This Benefit Event will automatically process and close after 14 days.

Generally, this Benefit Event does not allow the employee to make changes to their enrollments. However, this Benefit Event remains open for 14 days for instances where the employee was enrolled in an HMO plan that they are no longer eligible for at the new Agency based on region (Northern VA or rest of VA).

Once this Benefit Event closes (after 14 Days), the employee will receive a Confirmation Statement.



Receiving Agency (continued)

The Receiving Agency BN Administrator must complete the following:

- Monitor for open “XFR” Benefit Events. The Benefit Event Status Report should be generated and reviewed regularly to monitor all open Benefit Events to include “XFR” Benefit Events
- Review the employee’s benefits information to ensure that the employee’s Health Insurance, Premium Rewards, Imputed Life, and FSA enrollments carried over with no gap
- If the employee was enrolled in an HMO Plan that they are no longer eligible for, inform the employee to complete a new Benefit Enrollment form and then complete their new election via the “XFR” Benefit Event (within 14 days)
- If the employee was previously enrolled in a Deferred Compensation or Annuity Plan, advise the employee to re-enroll via the Vendor’s website. VRS Retirement Plans will feed back into Cardinal from VNAV as applicable



Lesson Summary

4

Processing New Hire Enrollments and Transfers

In this lesson, you learned

- General Information about New Hire Enrollments
- How to process a New Hire Enrollment
- How to view employee benefits information (current and historical)
- How to re-open and reprocess Benefit Events
- How to view an employee's Confirmation Statement
- An overview of the Inter-Agency Transfer Process



Lesson

5

Processing Manual Benefit Events

This lesson covers the following topics:

- Manual Benefit Events Overview
- Life Events Overview
- Overview of the Benefit Event Entry Page
- Processing Life Events
- QMCSO Overview
- Processing QMCSO Benefit Events



Manual Benefit Events General Information

Reminder: All benefit enrollments or changes are made through a Benefit Event.

Manual Benefit Events are triggered when any of the following occur:

- A Personal and or Job Data change is entered by an Agency HR Administrator (some of these triggered Benefit Events will automatically close if the Personal or Job Data change does not make the employee eligible to update their Benefit enrollments)
- Employee submits a Benefit enrollment form and the Benefits Administrator creates an Event on the Benefit Event Entry page
- Employee enters a Life Event or Open Enrollment through Employee Self-Service (ESS)
- A QMCSO Order is received (Event created on the Benefit Event Entry page)



Manual Benefit Events General Information (continued)

The date of the Benefits enrollment is driven based on the Event Date (Life Event, QMSCO Order received).

The Event Date is systematically generated based on the information entered on the Benefit Event Entry page.

For Life Events, employees have 60 days* to either:

- Submit a Benefits form with the applicable supporting documentation
or
- Initiate the Life Event through ESS and then submit the applicable supporting documentation

* **Note:** Enrollment can still be processed after 60 Days, however, OHB approval will be required in these cases.



Manual Benefit Events General Information (continued.)

The coverage begin and deduction begin dates will vary based on the specific type of Life Event. Some examples include:

Life Event	Coverage Begin and Deduction Begin Date
Marriage	1 st Day of the Month after the marriage date
Birth	Immediately on date of birth
Divorce	1 st Day of the Month after the divorce date

Plan elections are transmitted to the Vendor nightly (Monday – Friday excluding holidays).

Confirmation Statements will be available after the Benefits Administration process runs.

Note: See the Appendix for a list of the Manual Benefit Events.



Life Events



Life Events General Information

Life Events are a type of Benefit Event and are also referred to as Qualifying Mid-Year Events.

There are various types of Life Events to include:

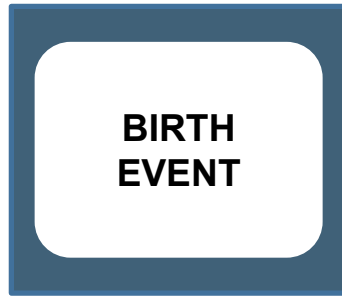

Reminder: Employees have 60 Days to initiate a Life Event after the event date. Enrollment can still be processed after 60 Days, however, OHB approval will be required in these cases.



Key Benefit Dates Related to Life Events

Benefit Enrollment Field	Definition
ELECTION DATE	The date the employee elects their benefits. This is typically the date the coverage changes are entered into the system.
BAS ACTIVITY EVENT DATE	The date used for entry when performing manual Benefit Events. This is based on the date the Life Event occurred.
COVERAGE BEGIN DATE	The date the coverage starts.
DEDUCTION BEGIN DATE	The date the deduction begins for the employee. This will be the Pay Period start date for the Pay Period that the coverage begin date falls in.



Life Event Example: Marriage

Scenario: An employee got married on 8/15. This is a Qualifying Mid-Year Event which allows the employee to update their Benefit enrollments. On 8/17, the spouse was added as a dependent with an effective date of 8/15. The employee elected to change their benefit plan from “SINGLE” to “EMPLOYEE + SPOUSE” and the enrollment was completed on 1/17. In this scenario, the following dates apply:

- **ELECTION DATE** = 8/17
- **BAS ACTIVITY EVENT DATE** = ____ ?
- **COVERAGE BEGIN DATE** = ____ ?

Note for Localities: Deduction begin dates are not applicable.



Life Event Example: Marriage (continued)

Scenario: An employee got married on 8/15. This is a Qualifying Mid-Year Event which allows the employee to update their Benefit enrollments. On 8/17, the spouse was added as a dependent with an effective date of 8/15. The employee elected to change their benefit plan from “SINGLE” to “EMPLOYEE + SPOUSE” and the enrollment was completed on 8/17. In this scenario, the following dates apply:

- **ELECTION DATE = 8/17/2023**
- **BAS ACTIVITY EVENT DATE = 8/17/2023**
- **COVERAGE BEGIN DATE = 9/1/2023**

Note for Localities: Deduction begin dates are not applicable.



Benefit Event Entry Page

The Benefit Event Entry page simplifies the creation of Benefit Events.

This page performs the following functions:

- Captures Life Event details
 - Life Event Date
 - Paperwork Receipt Date
 - Prior and Future Coverage Levels
 - Type of Benefit Change
- Calculates correct Benefit Event Dates
- Automatically selects the correct Benefit Class
- Creates the Benefit Event



Benefit Event Entry Page (continued)

[< Cardinal Homepage](#) Benefit Event New Window | Help | Personalize Page

Benefit Event Detail

Jason Witten Employee ID 00136680400 Benefit Record Number 0

Life Event 1 of 1 | View All

Life Event +

Life Event Date Paperwork Receipt Date

Health Change

Health Change Needed:

Current Cov. Level: Future Cov. Level:

Change:

FSA Change

FSA Change Needed:

Change:

Special Processing Message (Health)

Special Processing Message (FSA)

[Save](#) [Return to Search](#)



Viewing an Employee's Historical Benefits Information

Historical benefits information can be viewed on the **Health Benefits** page at any time. Navigate to the **Health Benefits** page using the following path:

Benefits Administrator tile > Enroll in Benefits > Health Benefits

[New Window](#)

Health Benefits

Thomas Jones30 Employee ID 00858056800 Benefit Record Number 0

Plan Type Q | << < 1 of 1 > >> | View All

Plan Type 10 Medical + -

Coverage Q | << < 1 of 1 > >> | View All

*Coverage Begin Date 11/01/2022 *Deduction Begin Date 11/01/2022 + -

Coverage Election

Elect Waive Terminate *Election Date 12/13/2022

Benefit Program SalBenPrgm
Benefit Plan ACC0 COVA Care + Prev Dental Option Code 25
Coverage Code 1 Single
Health Provider ID Previously Seen

Employee Status Active



QMCSO



Qualified Medical Court Support Order (QMCSO) General Information

Reminder: All benefit enrollments or changes are made through a Benefit Event.

A Qualified Medical Court Support Order (QMCSO) requires the employer group health plan to extend health coverage to a child of an eligible participant. A QMCSO can be in the form of either a Medical Child Support Order or a National Medical Support Notice (NMSN). In Cardinal, the term QMCSO is used to represent both of these types.

The QMCSO Participants Query (V_BN_PARTIC_QMCSO) can be used to view all employees and their dependent(s) that are currently associated with a QMCSO. For more information and instructions on how to run this query, refer to the HCM Reports Catalogs. The HCM Reports Catalogs are located on the Cardinal Website in **Reports Catalogs** under [Resources](#).



QMCSO General Information

When a QMCSO is received, the following actions need to be taken by the Agency BA outside of Cardinal before processing a QMCSO Benefit Event:

Review the QMCSO and determine:

- Confirm that the employee (participant) is employed within the Agency
- Verify with Agency payroll that the required employee contribution to extend health coverage to the child can be withheld without violating applicable Federal and State withholding limitations or withholding prioritization laws
 - If approved, send notification to the Court or Issuing Agency and the employee (participant)
 - If denied, send notification to the Court or Issuing Agency and the employee (participant) that the QMCSO is not qualified and provide an explanation for denial (ex; employee terminated, defective or missing information, violates withholding limitations or withholding prioritization laws)*

* Court or Issuing Agency may submit a new or revised QMCSO



QMCSO Process Flow

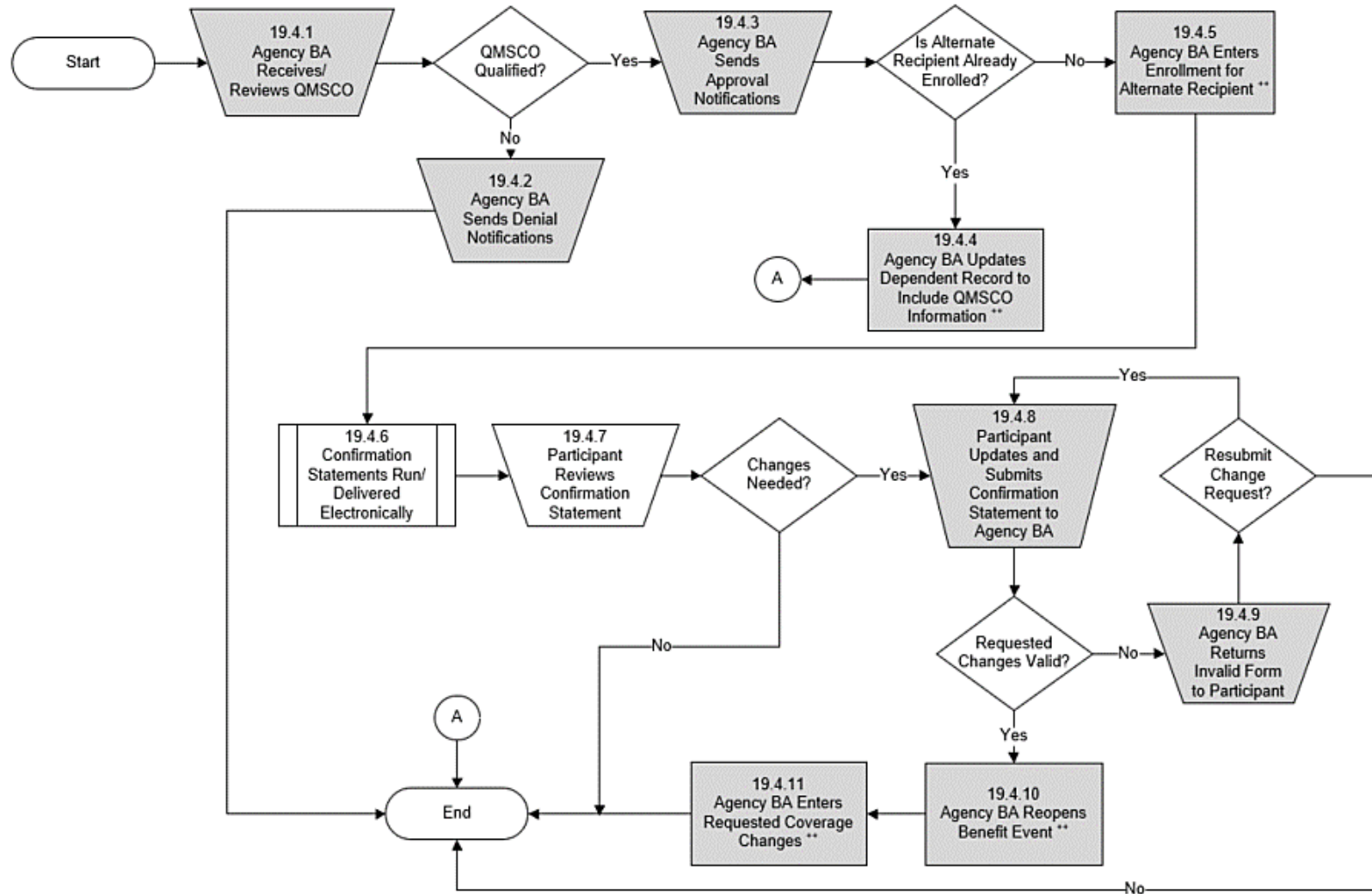

Note: For agencies supported by DHRM Shared Services, the steps in gray will be completed by DHRM, not the agency BA.



Key Benefit Dates Related to QMCSO Benefit Events

Benefit Enrollment Field	Definition
ELECTION DATE	The date the QMCSO Order is added and the enrollments completed by the BN Administrator.
BAS ACTIVITY EVENT DATE	The date used for entry when performing manual Benefit Events. This is the date the QMCSO Order was received.
COVERAGE BEGIN DATE	The date the coverage starts.
DEDUCTION BEGIN DATE	The date the deduction begins for the employee. This will be the Pay Period start date for the Pay Period that the coverage begin date falls in.

The BAS Activity Event Date will be systematically calculated when the Manual Benefit Event is created on the Benefit Event Entry page.



Lesson Summary

5

Processing Manual Benefit Events

In this lesson, you learned

- An Overview of Manual Benefit Events
- An Overview of Life Events
- An Overview of the Benefit Event Entry Page
- How to process Life Events
- A QMCSO Overview
- How to process QMCSO Benefit Events



Lesson

6

Viewing Other Employee and Dependent Benefits Information

This lesson covers the following topics:

- Viewing Dependent Information
- Viewing and Creating Disability Certifications
- Monitoring Employee/Dependent Eligibility Information
- Viewing Spending Account Information
- Premium Reward Overview
- Viewing Premium Reward Information



Viewing Dependent Information

Benefits Administrators have the ability to view and or update dependent information on the **Update Dependent/Beneficiary** page. This page is accessed using the following navigation path:

NavBar > Menu > Benefits > Employee/Dependent Information > Update Dependent/Beneficiary

The key information available to review/update on this page for each dependent includes:

- Name, Address, Contact Information (Phone and Email), Date of Birth, Dependent Beneficiary Type (Approved or Unapproved Dependent), Gender, Marital Status, Disability Status, Student Status, and QMCSO Rider/Order Status

Note: All dependents, regardless of whether they are currently enrolled in a Benefits Plan, will display and be available to view on this page. This data is maintained within Cardinal for cases where the dependent may need to be re-enrolled in a Benefits Plan in the future.



Viewing and Creating Disability Certifications

The ability for employees to continue coverage for child dependents up to the age of 26 is based on their student status.

Employees can only continue coverage for child dependents after the age of 26 when the dependent has a documented disability. In this case, a Benefits Administrator must create a Disability Certification for the employee and associate it with the corresponding dependent.

Reviewing existing Disability Certifications and creating new Disability Certifications is completed on the **Maintain Certifications** page. This page is accessed using the following navigation path:

NavBar > Menu > Benefits > Employee/Dependent Information > Maintain Certifications

Note: Disability Certifications must be re-certified every 2 years.



Monitoring Employee/Dependent Eligibility Information

The Benefit Eligibility Audit reports are used to monitor and identify employees or dependents meeting specific criteria which may require the Benefits Administrator to take action. The Benefits Eligibility Audit reports are generated using the following navigation path:

Menu > Benefits > Reports > Audits > Benefit Eligibility Audits

The user will then have the option to generate one or more of the following Reports:

- Dependent Waiting Approval Report
- Retired, Tricare and TLC Employees Approaching 65 Report
- Dependent of Retirees/Tricare/TLC employees Approaching 65
- Dependent Child Approaching 26
- Disabled Over-Age Dependent Child

For more information and instructions on how to run these Reports, refer to the HCM Reports Catalogs. The HCM Reports Catalogs are located on the Cardinal Website in **Reports Catalogs** under [Resources](#).



Viewing an Employee's Spending Account Information

Spending Account information can be viewed on the **Spending Accounts** page at any time. Navigate to the **Spending Accounts** page using the following path:

Menu > Benefits > Enroll in Benefits > Spending Accounts

The employee's current and historical Spending Account information can be viewed on this page.



Premium Reward General Information

Eligible employees can receive a Premium Reward in order to offset the cost of their medical premium.

Premium Rewards are centrally processed and established based on the following:

- Participants are included in the Premium Rewards file received by Cardinal if they satisfy the requirements to earn the premium reward
- The Premium Rewards file is automatically uploaded, and the participant is enrolled in the Simple Benefit plan
- An additional pay is established to offset the cost of the medical premium
- If the Additional Pay needs to be manually updated for an employee, reach out to an HR Administrator to make the adjustments necessary
- In the scenario that a Premium Reward for an employee needs to be manually updated, the Agency BA will create a manual event (**FSC BAS Action**) on the **Review BAS Activity** page to open the enrollment options and make the necessary changes



Viewing Premium Reward Information

Premium Reward information can be viewed on the **Simple Benefits** page at any time. Navigate to the **Simple Benefits** page using the following path:

Menu > Benefits > Enroll in Benefits > Simple Benefits

The employee's current and historical information can be viewed on this page. Flex Spending Medical Fees are also available for review on this page.



Lesson Summary

6

Viewing Other Employee and Dependent Benefits Information

In this lesson, you learned

- How to View Dependent Information
- How to View and Create Disability Certifications
- How to Monitor Employee/Dependent Eligibility Information
- How to View Spending Account Information
- Premium Reward Overview
- How to View Premium Reward Information



Lesson

7

COBRA Administration

This lesson covers the following topics:

- Overview of COBRA
- Monitoring COBRA Eligibility and Status



COBRA Overview

COBRA is an extension of the current group health insurance plan offered to employees after they have left the Organization. This coverage can be kept for up to 18 months and is only available to individuals and dependents covered under a plan with more than 20 employees enrolled.

Upon onboarding with the Agency, a General Letter must be distributed to every employee and spouse regarding COBRA. This General Letter is not systematically generated by Cardinal and is created and distributed by the Agency.



COBRA Overview (continued)

After onboarding with the Agency, there are various reasons that an employee, spouse, or child dependent may become eligible (COBRA qualifying events) to enroll in COBRA.

Employee	Spouse	Child Dependent
Job Transaction: Termination	Marital Status Change for the Employee to “Divorced”	Removal of child dependent by the employee
Job Transaction: Reduction in Hours	Death of the employee	Child dependent going over the age of 26 (no disability status)
Waiving Coverage		
Retirement		



COBRA Overview (continued.)

COBRA processing is centralized at the Office of Health Benefits (OHB). When an employee, spouse, or child dependent(s) becomes eligible for COBRA, no processing action is required by the Agency Benefits Administrator. OHB will send the COBRA Notification Letter(s).

If the employee, spouse, and child dependent(s) elects to enroll in COBRA, OHB will process and manage the enrollment.



Monitoring COBRA Eligibility and Status

Although OHB performs all actions related to COBRA, other than the initial distribution of the General Letter(s) upon onboarding, the Agency Benefits Administrators have the ability to monitor COBRA eligibility and the current status.

The Agency BA can monitor an employee and dependent COBRA eligibility and status in the following ways:

- The Review Event Summary Page
- Event Summary Report
- COBRA Enrollment Report



Monitoring COBRA Eligibility and Status (continued)

Review Event Summary page can be viewed to review information to include the Event Class (reason for COBRA eligibility), Qualification Status, Process Status, and health coverage information (coverage begin and end date). Navigate to this page using the following path:

Menu > Benefits > Administer COBRA Benefits > Review Processing Results > Review Event Summary



Monitoring COBRA Eligibility and Status (continued).

There are several reports that the BA can generate to monitor COBRA eligibility and status:

Event Summary Report: Provides a list of all COBRA eligible individuals with event and enrollment status. Generate this report using the following navigation path:

Menu > Benefits > Administer COBRA Benefits > Review Processing Results > Event Summary Report

COBRA Enrollment Report: Displays all individuals enrolled in COBRA along with their health coverage information (coverage begin and end date) and dependent information. Generate this report using the following navigation path:

Menu > Benefits > Administer COBRA Benefits > Review Processing Results > Enrollment Report

For more information and instructions on how to run the Event Summary Report or COBRA Enrollment Report, refer to the HCM Reports Catalogs. The HCM Reports Catalogs are located on the Cardinal Website in **Reports Catalogs** under [Resources](#).



Lesson Summary

7

COBRA Administration

In this lesson, you learned

- An Overview of COBRA
- How to Monitor COBRA Eligibility and Status



Lesson

8

Health Benefits Reconciliation

This lesson covers the following topics:

- Overview of the Health Benefits Reconciliation Process
- Generating and Reviewing Health Benefits Reconciliation Reports



Health Benefit Reconciliation Overview

The Health Benefit Reconciliation process is completed in order to identify differences between the expected contributions and the amounts collected in Cardinal Payroll for health benefits.

- This reconciliation is completed on a monthly basis by an Agency BN or PY Administrator
- This process is only completed by Payroll Agencies. For Agencies supported by the Payroll Service Bureau (PSB), PSB will complete the reconciliation



Health Benefit Reconciliation Overview

The Health Benefit Reconciliation Program is run monthly by the Cardinal PPS Team. This program:

- Automatically compares Cardinal effective dated health benefit enrollments with payroll deductions to determine and report variances in the health benefit premium
- This program does not include retroactive adjustments for previous months
- Automatically generates General Ledger Journals (Healthcare Reconciliation Journal Creation Program) to refund overpayments and charge under collections to the Agencies. This program is run by the Cardinal PPS Team



Health Benefits Reconciliation Process Flow (continued)

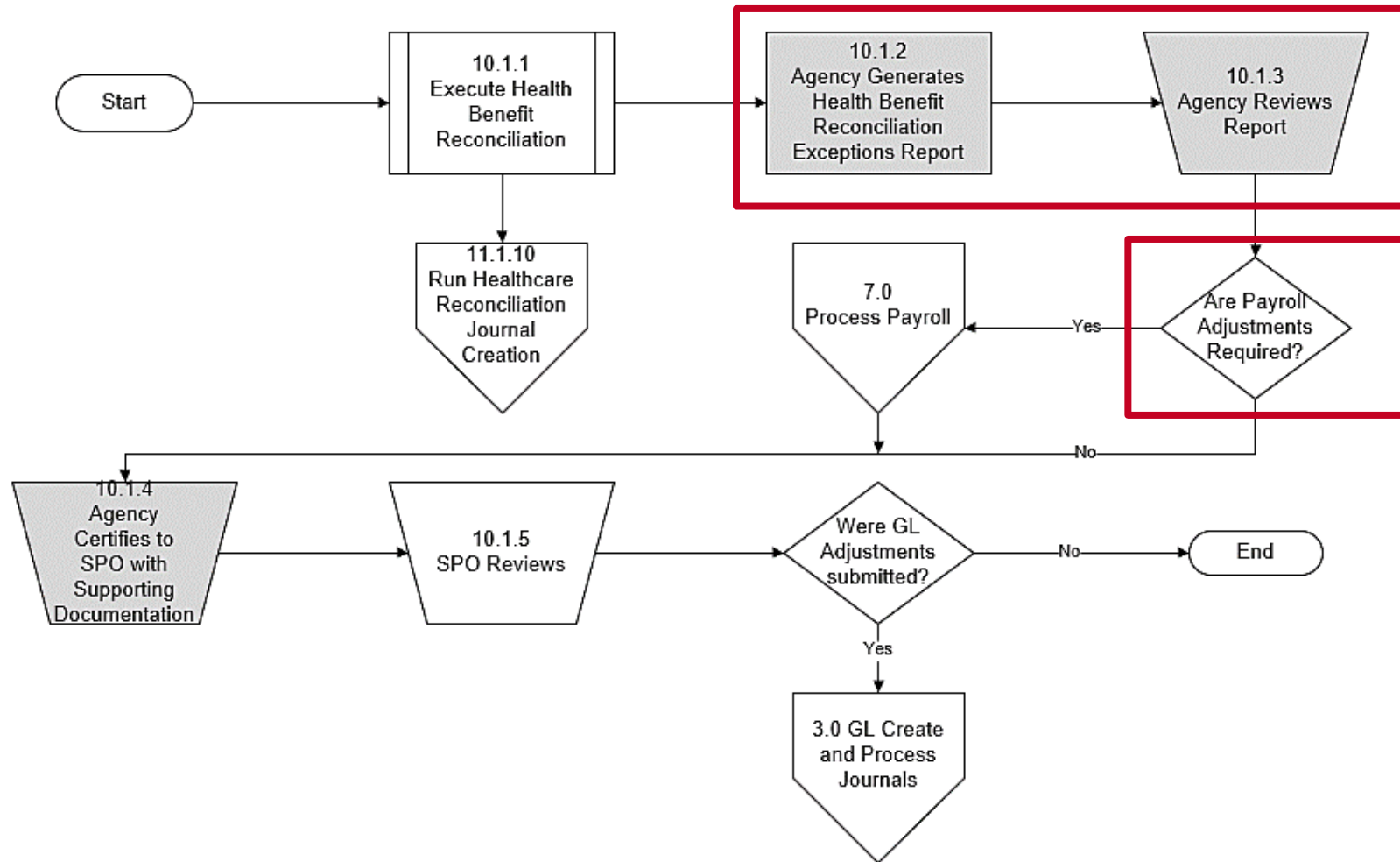

Note: For agencies supported by DHRM Shared Services, the steps in gray will be completed by DHRM, not the agency BA.



Reviewing Health Benefit Reports

After the Health Benefit Reconciliation Program is run and the payroll schedule posts, Agency personnel (Benefits Administrators and Payroll Administrators) generate and review the following reports:

- Health Benefit Reconciliation Exception Report

NavBar > Menu > Benefits > Reports > Health Benefit Recon Exception

- Benefit Contribution Register

NavBar > Menu > Benefits > Reports > Contributions and Deductions > Benefit Contribution Register



Reviewing Health Benefit Reports

Health Benefit Reconciliation Exception Report:

- Lists variances between monthly payroll contributions and the enrollment records (i.e., discrepancies between employee premiums, employer premiums, and total premiums)
- Lists variances between the expected amount and payroll amount for Premium Rewards

Agency personnel use this report to identify required General Ledger adjustments and contact SPO accordingly.

For more information and instructions on how to run these reports, refer to the HCM Reports Catalogs. The HCM Reports Catalogs are located on the Cardinal Website in **Reports Catalogs** under [Resources](#).



Reviewing Health Benefit Reports (continued)

Benefit Contribution Register:

- Lists the employee and employer benefit contributions for all Benefit Plans (summarizes the benefit contributions made in payroll (Cardinal Payroll only) by the employee and the employer)
- Contribution amounts for the current period and the year-to-date are included in this report
- Access is based on Agency Level Security in order to limit the information available for review by a specific user

Agency Benefit Administrators use this report to review the employee and employer benefit contributions

For more information and instructions on how to run these reports, refer to the HCM Reports Catalogs. The HCM Reports Catalogs are located on the Cardinal Website in **Reports Catalogs** under [Resources](#).



Sample Health Benefits Recon Exceptions Report

 Report ID: RHR070	Commonwealth of Virginia HEALTH BENEFITS RECON EXCEPTIONS REPORT	Run Date: 01/06/2023 Run Time: 02:04 00
--	--	--

Page No. 1 of 14

Business Unit: 50100 - VA Dept of Transportation

Coverage Year: 2022 Coverage Month: August

Benefit Group ID: DOT10017

Health Plan	Employee Name	EMPLID	Cvg Cd	Ded Cls	Expected Premium	Collected Premium	GL Actvy Charge (Credit)	Ded Not Taken	Arrears Paid Back	Refunds Processed	Possible Action Required
Deduction: CoVA Care											
ACC5	Beesley, Pam	00151588300	2	B	350.00	0.00	350.00	0.00	0.00	0.00	Addl premium required
	Beesley, Pam	00151588300	2	N	1,268.00	0.00	1,268.00	0.00	0.00	0.00	Addl premium required
	ACC5 Total						1,618.00				
	Deduction: CoVA Care Total						1,618.00				
DOT10001 Group Total							\$	1,618.00			
Deduction: COVA Health Aware											
CHA2	Scott, Michael	00523416500	4	B	139.00	0.00	139.00	0.00	0.00	0.00	Addl premium required
	Scott, Michael	00523416500	4	N	1,856.00	0.00	1,856.00	0.00	0.00	0.00	Addl premium required
	CHA2 Total						1,995.00				
	Deduction: COVA Health Aware Total						1,995.00				
DOT10004 Group Total							\$	1,995.00			
Deduction: COVA Health Aware											
CHA2	Halpert, Jim	00690858500	4	B	139.00	0.00	139.00	0.00	0.00	0.00	Addl premium required
	Halpert, Jim	00690858500	4	N	1,856.00	0.00	1,856.00	0.00	0.00	0.00	Addl premium required
	CHA2 Total						1,995.00				
	Deduction: COVA Health Aware Total						1,995.00				
DOT10006 Group Total							\$	1,995.00			
Deduction: COVA Health Aware											
CHA2	Hannon, Erin	00847114900	4	B	139.00	208.50	(69.50)	0.00	0.00	0.00	May be owed a refund
	Hannon, Erin	00847114900	4	N	1,856.00	2,784.00	(928.00)	0.00	0.00	0.00	May be owed a refund
	CHA2 Total						(997.50)				
	Deduction: COVA Health Aware Total						(997.50)				
DOT10011 Group Total							(\$	997.50)			
Deduction: COVA Health Aware											
NOENRL	Howard, Ryan	00352384600	N/A	B	0.00	30.00	(30.00)	0.00	0.00	0.00	May be owed a refund
	Howard, Ryan	00352384600	N/A	N	0.00	347.50	(347.50)	0.00	0.00	0.00	May be owed a refund



Sample Health Benefits Recon Exceptions Report



Report ID: RHR070

Commonwealth of Virginia

HEALTH BENEFITS RECON EXCEPTIONS REPORT

Run Date: 01/06/2023

Run Time: 02:04 00

Page No. 13 of 14

Business Unit: 50100 - VA Dept of Transportation

Coverage Year: 2022

Coverage Month: August

Employee Health Premium Reward Variances between Benefits and Payroll

<u>Employee Name</u>	<u>EMPLID</u>	<u>Expected Premium Reward</u>	<u>Payroll Premium Reward</u>	<u>Prem Rwd Difference</u>	<u>Possible Action Required</u>
Brady, Tom	00765410800	17.00	8.50	8.50	Employee did not receive correct Premium Reward. Pay difference on next pay period
Rogers, Aaron	00736240700	0.00	(8.50)	8.50	Employee did not receive correct Premium Reward. Pay difference on next pay period
Tannehill, Ryan	00242406000	0.00	(17.00)	17.00	Employee did not receive correct Premium Reward. Pay difference on next pay period
Smith, Geno	00575794000	0.00	17.00	(17.00)	Employee Premium Reward incorrect. Collect difference on next pay period
Wilson, Russell	00283377300	0.00	(8.50)	8.50	Employee did not receive correct Premium Reward. Pay difference on next pay period
Stafford, Matthew	00458558600	0.00	(17.00)	17.00	Employee did not receive correct Premium Reward. Pay difference on next pay period
Dalton, Andy	00641845400	0.00	(8.50)	8.50	Employee did not receive correct Premium Reward. Pay difference on next pay period
Roethlisberger, Ben	00290851700	17.00	0.00	17.00	Employee did not receive correct Premium Reward. Pay difference on next pay period
Flacco, Joe	00245015000	0.00	17.00	(17.00)	Employee Premium Reward incorrect. Collect difference on next pay period
Farve, Brett	00609324300	0.00	(8.50)	8.50	Employee did not receive correct Premium Reward. Pay difference on next pay period
Manning, Peyton	00255999700	17.00	34.00	(17.00)	Employee Premium Reward incorrect. Collect difference on next pay period
Montana, Joe	00436151900	0.00	(8.50)	8.50	Employee did not receive correct Premium Reward. Pay difference on next pay period
Aikman, Troy	00482524000	0.00	(17.00)	17.00	Employee did not receive correct Premium Reward. Pay difference on next pay period
Newton, Cam	00294468600	34.00	51.00	(17.00)	Employee Premium Reward incorrect. Collect difference on next pay period
Driskel, Jeff	00682129700	0.00	(17.00)	17.00	Employee did not receive correct Premium Reward. Pay difference on next pay period
Keenum, Case	00219329200	0.00	(8.50)	8.50	Employee did not receive correct Premium Reward. Pay difference on next pay period
Foles, Nick	00357063000	0.00	(17.00)	17.00	Employee did not receive correct Premium Reward. Pay difference on next pay period
Fitzpatrick, Ryan	00714482900	17.00	8.50	8.50	Employee did not receive correct Premium Reward. Pay difference on next pay period
Unitas, Jonny	00672057200	0.00	(8.50)	8.50	Employee did not receive correct Premium Reward. Pay difference on next pay period
Dawson, Len	00537397900	0.00	(8.50)	8.50	Employee did not receive correct Premium Reward. Pay difference on next pay period
Warner, Kurt	00803906900	0.00	(8.50)	8.50	Employee did not receive correct Premium Reward. Pay difference on next pay period
Hoyer, Brian	00228132600	0.00	(8.50)	8.50	Employee did not receive correct Premium Reward. Pay difference on next pay period
Rivers, Philip	00588762800	0.00	(17.00)	17.00	Employee did not receive correct Premium Reward. Pay difference on next pay period
Van Brocklin, Norm	00482531700	0.00	(8.50)	8.50	Employee did not receive correct Premium Reward. Pay difference on next pay period
Schaub, Matt	00171793500	0.00	(17.00)	17.00	Employee did not receive correct Premium Reward. Pay difference on next pay period
Brissett, Jacoby	00218227000	0.00	(17.00)	17.00	Employee did not receive correct Premium Reward. Pay difference on next pay period
Elway, John	00359000800	0.00	(8.50)	8.50	Employee did not receive correct Premium Reward. Pay difference on next pay period
McCoy, Colt	00608017000	17.00	8.50	8.50	Employee did not receive correct Premium Reward. Pay difference on next pay period
Manning, Eli	00393711200	0.00	(8.50)	8.50	Employee did not receive correct Premium Reward. Pay difference on next pay period
Johnson, Josh	00367399600	0.00	(17.00)	17.00	Employee did not receive correct Premium Reward. Pay difference on next pay period
Smith, Alex	00816190200	0.00	(8.50)	8.50	Employee did not receive correct Premium Reward. Pay difference on next pay period
Brees, Drew	00213113400	34.00	17.00	17.00	Employee did not receive correct Premium Reward. Pay difference on next pay period
Theisman, Joe	00672832700	0.00	(17.00)	17.00	Employee did not receive correct Premium Reward. Pay difference on next pay period
Kelly, Jim					
Testaverde, Vinny					



Sample Benefit Contributions Register Report

PeopleSoft
MONTHLY BENEFIT CONTRIBUTIONS REGISTER

Report ID: BEN003
Company: ACS Agriculture & Consumer Svcs
As Of Date:08/31/2022
Ben Program Salaried Employee Benefit Pgm
Plan Type Medical
Ben Plan ACCO

Page No. 1
Run Date 01/06/2023
Run Time 14:13:09

Employee Name	Ben Employee Rcd ID	Empl Status	Department ID	Department Name	----- Employee Deductions -----		----- Company Contributions -----	
					This Period	YTD	This Period	YTD
TROY AIKMAN	0 00015478700	A	33200	D and F	217.00	1,627.50	1,268.00	9,510.00
JOHN DOE	0 00440718000	A	33500	Vet Srv	94.00	705.00	709.00	5,317.50
JOHN DOE	0 00283602600	A	33200	D and F	295.00	2,212.50	1,859.00	13,942.50
JOHN DOE	0 00285244500	A	37200	Charit Reg	295.00	2,212.50	1,859.00	13,942.50
JOHN DOE	0 00046529000	A	37500	W and M	94.00	705.00	709.00	5,317.50
JOHN DOE	0 00147682800	A	37400	Plant Ind	94.00	705.00	709.00	5,317.50
JOHN DOE	0 00172605500	A	33200	D and F	94.00	705.00	709.00	5,317.50
JOHN DOE	0 00185955900	A	33400	MPI Srv	217.00	325.50	1,268.00	1,902.00
JOHN DOE	0 00193303600	R	37400	Plant Ind	217.00	2,095.50	1,268.00	13,056.00
JOHN DOE	0 00232316300	A	33200	D and F	94.00	705.00	709.00	5,317.50
JOHN DOE	0 00233000300	A	37200	Charit Reg	217.00	325.50	1,268.00	1,902.00
JOHN DOE	0 00266940700	A	35600	Grain	94.00	705.00	709.00	5,317.50
JOHN DOE	0 00270668400	A	34200	AFID	94.00	705.00	709.00	5,317.50
JOHN DOE	0 00274241000	A	31200	Finance	217.00	1,627.50	1,268.00	9,510.00
JOHN DOE	0 00274910500	A	37400	Plant Ind	295.00	442.50	1,859.00	2,788.50
JOHN DOE	0 00276840900	A	33500	Vet Srv	217.00	1,627.50	1,268.00	9,510.00
JOHN DOE	0 00281145500	A	33300	Lab Srv	295.00	2,212.50	1,859.00	13,942.50
JOHN DOE	0 00300403000	A	31200	Finance	94.00	705.00	709.00	5,317.50
JOHN DOE	0 00302682600	A	30500	Comm	295.00	2,212.50	1,859.00	13,942.50
JOHN DOE	0 00309864300	A	37300	Pesticide	217.00	889.50	1,268.00	6,156.00
JOHN DOE	0 00310218000	A	30600	Policy	295.00	2,212.50	1,859.00	13,942.50
JOHN DOE	0 00310631700	A	33300	Lab Srv	295.00	2,212.50	1,859.00	13,942.50
JOHN DOE	0 00352487500	A	37200	Charit Reg	217.00	1,627.50	1,268.00	9,510.00
JOHN DOE	0 00357717000	A	33100	AFIS Admin	295.00	2,212.50	1,859.00	13,942.50
JOHN DOE	0 00362370100	A	33500	Vet Srv	94.00	705.00	709.00	5,317.50
JOHN DOE	0 00365059500	A	33200	D and F	94.00	705.00	709.00	5,317.50
JOHN DOE	0 00367334000	A	35400	Livestock	295.00	2,212.50	1,859.00	13,942.50
JOHN DOE	0 00371504800	A	31400	Info Sys	295.00	442.50	1,859.00	2,788.50
JOHN DOE	0 00400145000	A	31200	Finance	94.00	423.00	709.00	3,190.50
JOHN DOE	0 00405282100	A	37500	W and M	94.00	141.00	709.00	1,063.50
JOHN DOE	0 00416920700	A	33200	D and F	295.00	2,212.50	1,859.00	13,942.50
JOHN DOE	0 00419835900	A	31400	Info Sys	295.00	442.50	1,859.00	2,788.50
JOHN DOE	0 00431717800	A	35100	CS Admin	217.00	1,627.50	1,268.00	9,510.00
JOHN DOE	0 00450462800	A	33100	AFIS Admin	295.00	2,212.50	1,859.00	13,942.50
JOHN DOE	0 00463869400	A	33200	D and F	295.00	2,212.50	1,859.00	13,942.50
JOHN DOE	0 00501826200	A	37400	Plant Ind	94.00	705.00	709.00	5,317.50
JOHN DOE	0 00502713500	A	37500	W and M	295.00	2,212.50	1,859.00	13,942.50
JOHN DOE	0 00503041900	A	33200	D and F	217.00	1,627.50	1,268.00	9,510.00
JOHN DOE	0 00504518600	A	33500	Vet Srv	295.00	2,212.50	1,859.00	13,942.50
JOHN DOE	0 00525657400	A	33500	Vet Srv	295.00	2,212.50	1,859.00	13,942.50
JOHN DOE	0 00525658600	A	33200	D and F	295.00	2,212.50	1,859.00	13,942.50



Health Benefits Reconciliation Process Flow (continued)

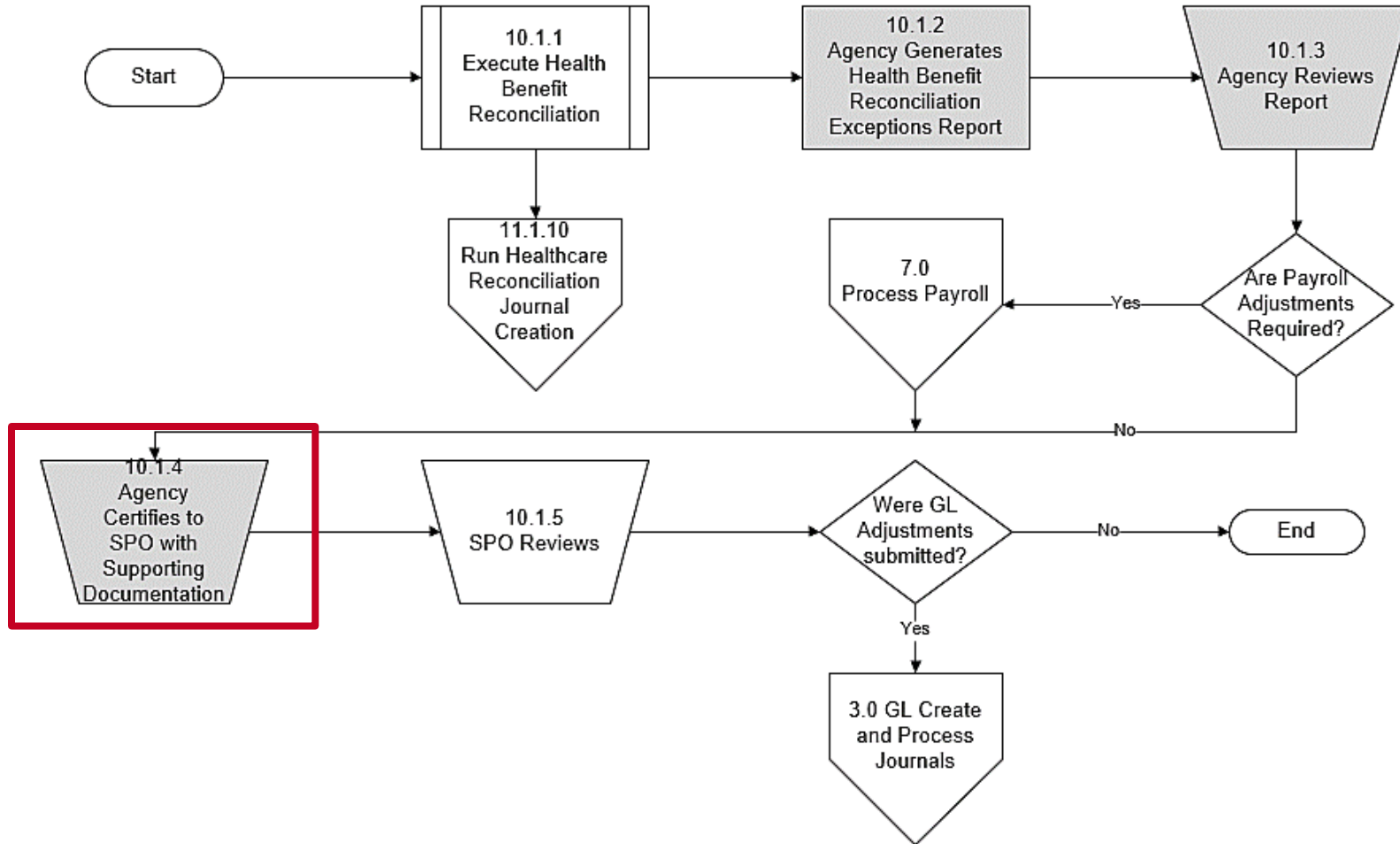

Note: For agencies supported by DHRM Shared Services, the steps in gray will be completed by DHRM, not the agency BA.



Agency Certification

Once the review is complete, the Agency completes the following:

- Agency Fiscal Officer certifies accuracy by signing the Certification Form after all health benefit premium amount variances and employee Premium Reward variances are reviewed
- Signed Certification Form and all supporting documentation (Certification Packet) is submitted to State Payroll Operations (SPO)



Health Benefits Reconciliation Process Flow (continued)

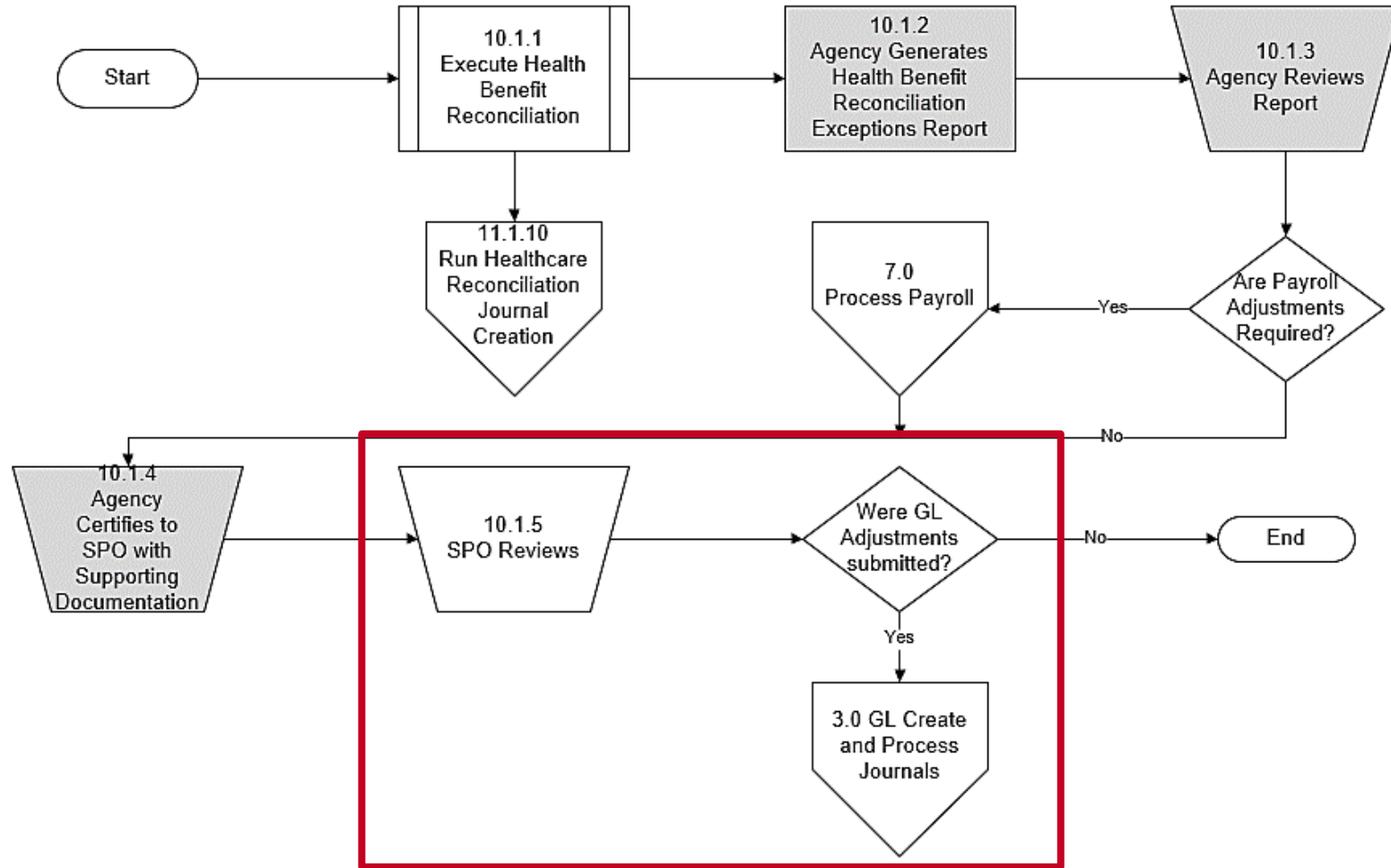



State Payroll Operations (SPO)

SPO reviews the Certifications Packets as they are received and:

- Verifies the adjustments requested (works with Agency or PSB as needed)
- Submits the GL Journal spreadsheet in accordance with published Cardinal Financials guidelines



Lesson Summary

8

Health Benefits Reconciliation

In this lesson, you learned

- An Overview of the Health Benefits Reconciliation Process
- How to Generate and Review Health Benefits Reconciliation Reports



Lesson

9

Affordable Care Act (ACA) Administration

This lesson covers the following topics:

- Overview of ACA Administration Process Flow
- Agency Responsibilities during ACA Reconciliation
- Generating the ACA Reconciliation Report
- Certifying the ACA Data



ACA Administration Overview

The **ACA Administration** business process involves:

- Capturing the data elements required to create annual regulatory forms for health benefit participants
- Capturing the data elements required to perform annual regulatory reporting to the Internal Revenue Service (IRS)



ACA Administration Process Flow

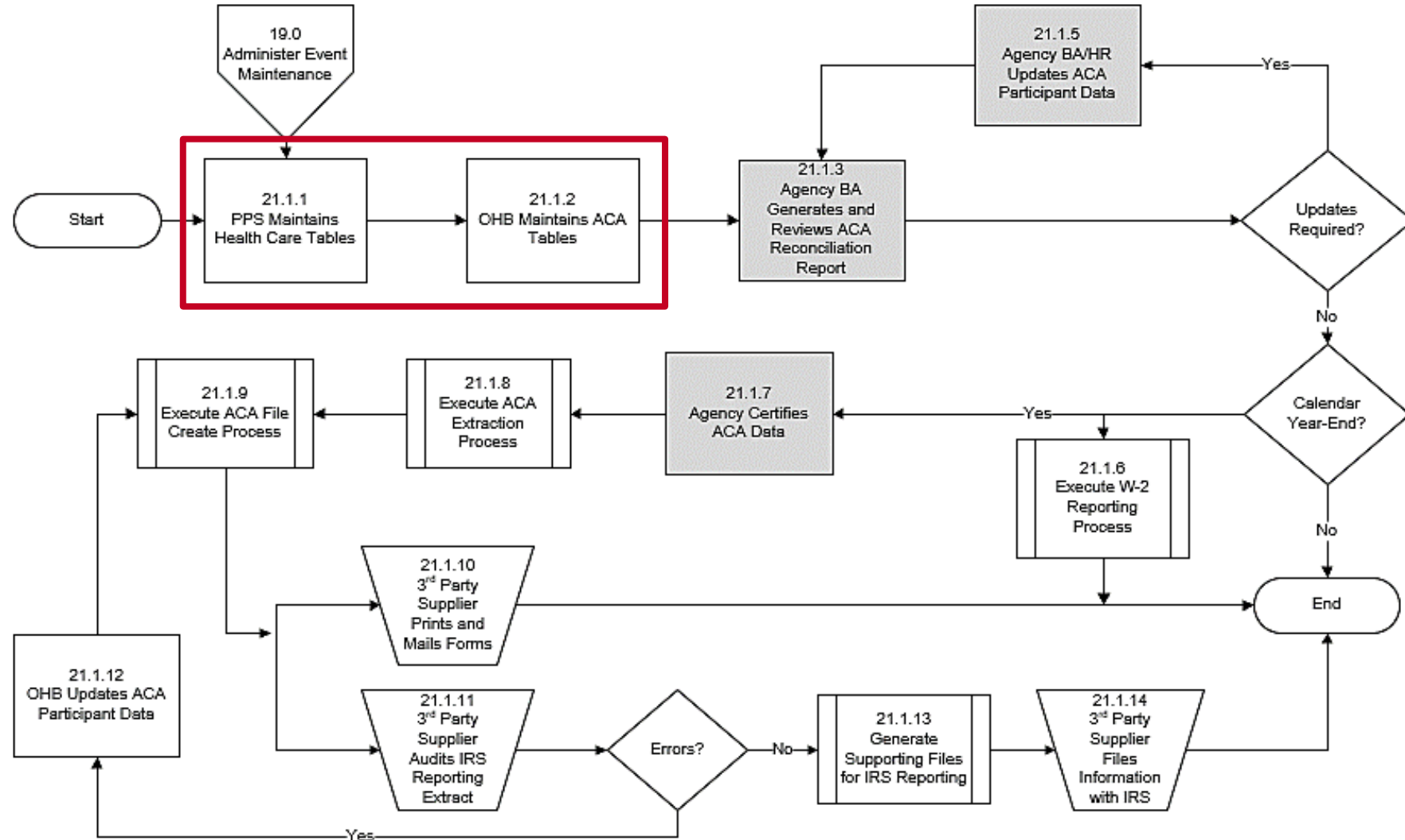



ACA Reconciliation Data Sources

Health Care Tables: Within Cardinal, the Health Care Tables are utilized to select the applicable plan and coverage code. These Tables are maintained by the Cardinal Post Production Support (PPS) Team.

ACA Tables: OHB maintains the ACA Tables which contain the approved ACA Health Benefit Plans.



ACA Administration Process Flow

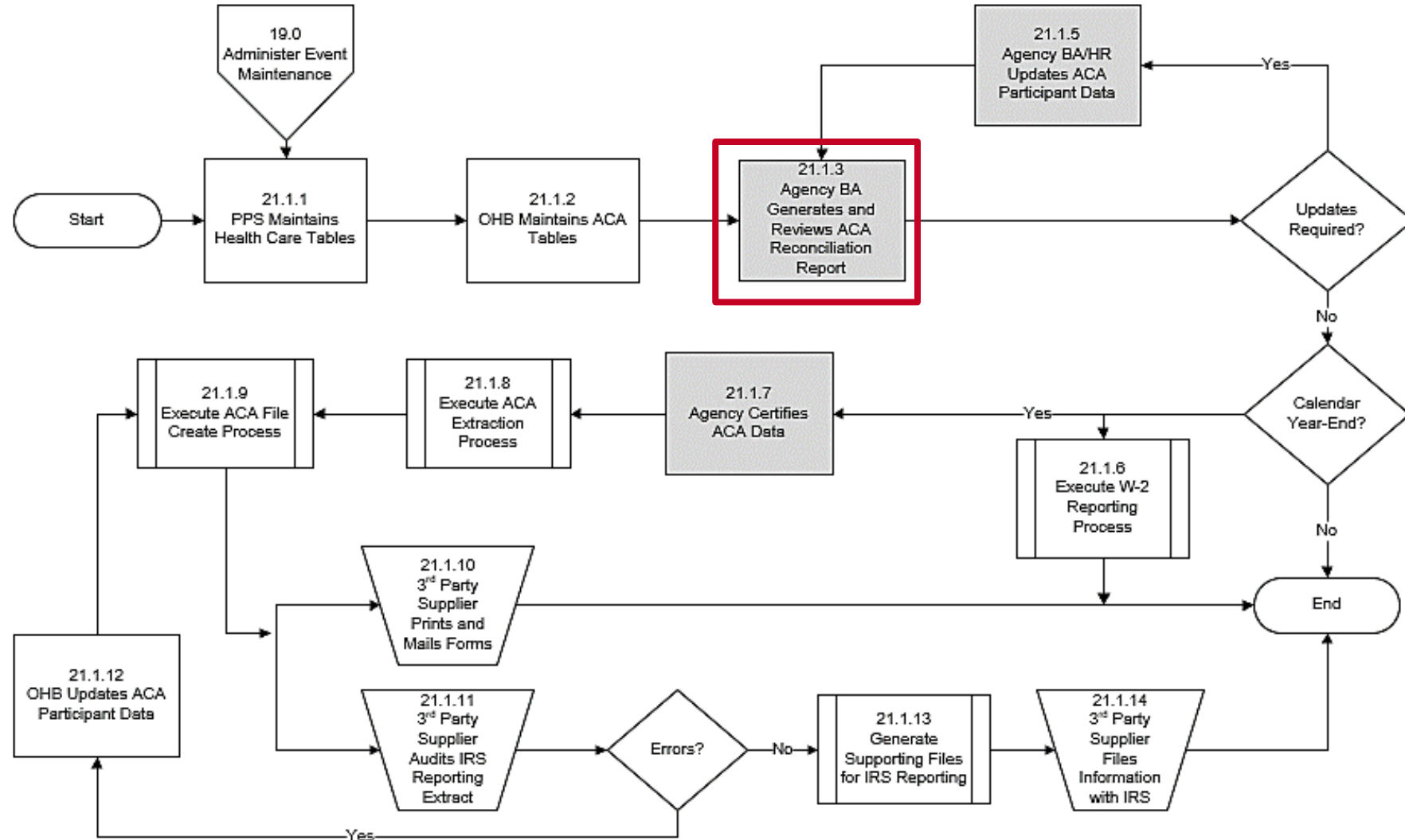

Note: For agencies supported by DHRM Shared Services, the steps in gray will be completed by DHRM, not the agency BA.



ACA Reconciliation Report

The ACA Reconciliation Report is used to view data that identifies all employment and enrollment statuses for each participant and dependent by Month.

- It is recommended to run this report on a Monthly basis
- This report must be run on a Quarterly basis at a minimum and must be run twice in the last quarter of the Calendar Year and the ACA Certification must be completed

Menu > Benefits > ACA Annual Processing > ACA Preparation > ACA Reconciliation Report

For more information and instructions on how to run this report, refer to the HCM Reports Catalogs. The HCM Reports Catalogs are located on the Cardinal Website in **Reports Catalogs** under [Resources](#).

Note: For Non Cardinal Payroll Agencies, this report is utilized to obtain the amounts that must be reported on the year-end W-2s for each employee. The healthcare premium amount (column L) is reported on the W-2, in box 12, with a code of “DD”. This process is completed by the Cardinal PPS Team.



ACA Reporting Process Flow

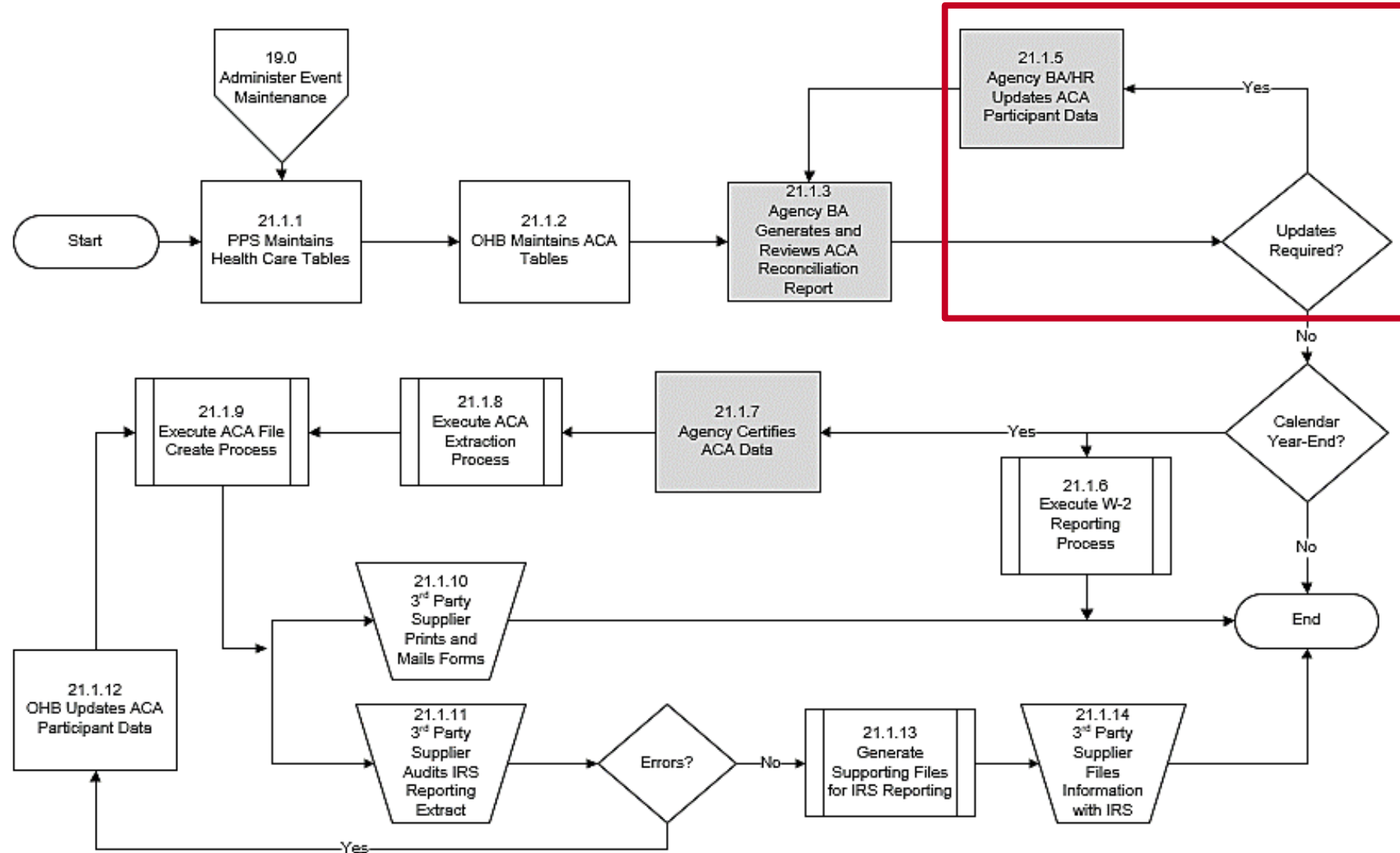

Note: For agencies supported by DHRM Shared Services, the steps in gray will be completed by DHRM, not the agency BA.



Review and Update ACA Participant Data

Agencies review the ACA Reconciliation Report to identify if any updates are required. If discrepancies are identified, one of the following corrective actions may be required:

- The Agency HR and BN Administrators will work together to trigger a Benefit Event and then process the corrective enrollments
- Employees (participants) will only display on the ACA Reconciliation Report if they have a record on the **ACA Employee Eligibility** page. The participant's eligibility may need to be manually corrected on this page if they are not displaying on the ACA Reconciliation Report



ACA Employee Eligibility Page

ACA Employee Eligibility page guidelines:

- On the employee's hire date, a row is automatically added to this page (effective dated based on the hire date) with a status of "Eligible" unless the hire date is the first of the Month. In these cases, only one row will be automatically added and the status will be "Always Eligible"
- For all hire dates other than the first of the Month, once the employee's elected benefits become effective, another effective dated row is added to this page with a status of "Always Eligible"
- If the employee is not eligible for health coverage, their status will be "Ineligible"

Menu > Benefits > Employee/Dependent Information > ACA Employee Eligibility

Sample ACA Employee Eligibility Page

Benefits Administrator ACA Employee Eligibility

New Window | Help | Personalize Page

ACA Employee Eligibility

Affordable Care Act Common ID DOT VA Dept of Transportation

Employee ID

Eligibility Information

*Effective Date: 02/01/2020

*ACA Eligibility Status: Always Eligible

Average Service Hours: 0.000

Calculation Method: Look Back

Effective Sequence: 0

Work Period: Monthly

Measurement Period:

Evaluation Begin Date:

Evaluation End Date:

Administration Begin Date:

Administration End Date:

Stability Begin Date:

Stability End Date:

Non-Assessment Period

ACA Calculation Hours

Empl Record	Company	Description	Total Hours
0			

Total Eligibility Hours

Last Update User ID BATCH Updated on 06/04/2020 12:33:06PM

OK Cancel Apply

- Always Eligible
- Always Eligible
- Eligible
- Excluded
- Ineligible
- To be determined



ACA Reporting Process Flow

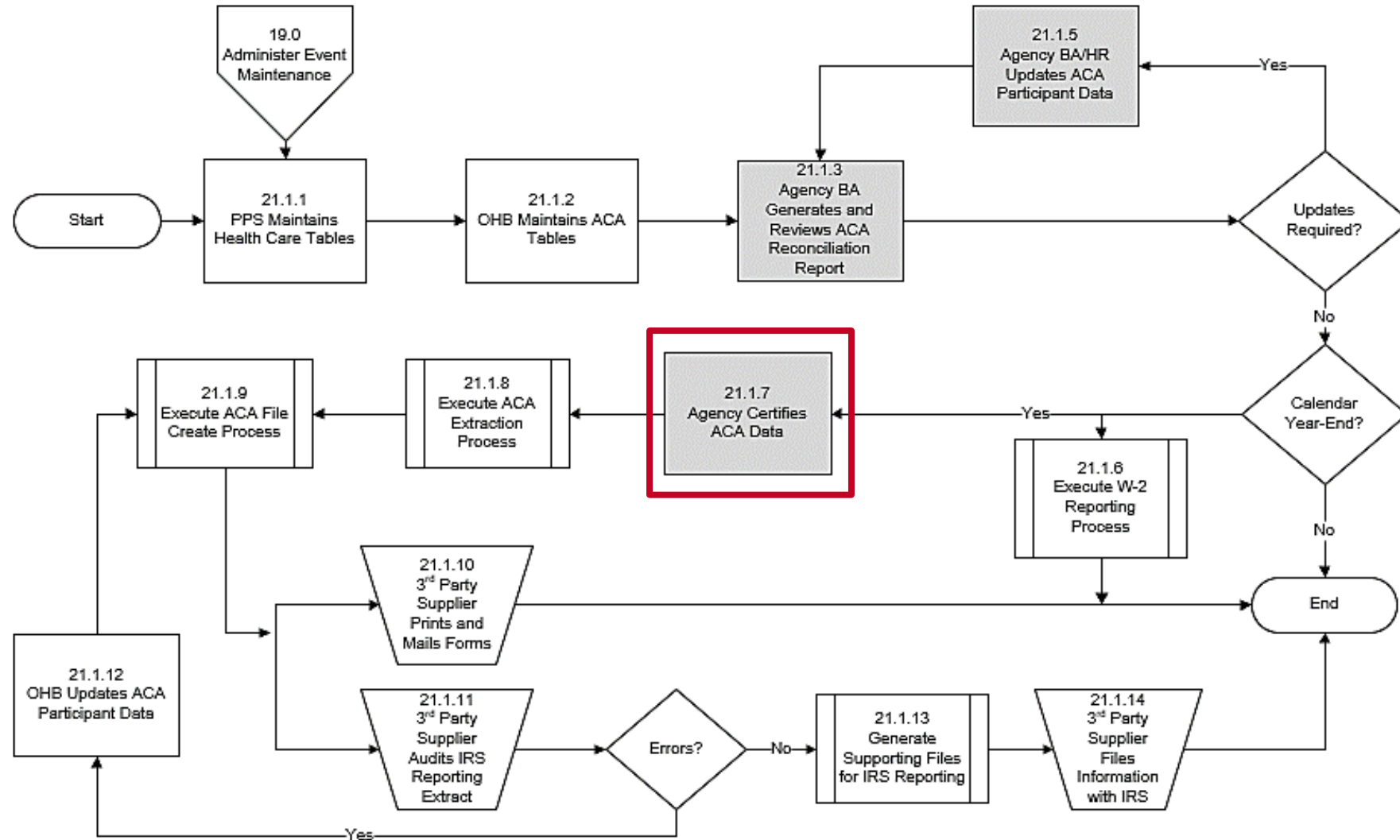

Note: For agencies supported by DHRM Shared Services, the steps in gray will be completed by DHRM, not the agency BA.



ACA Certification

The ACA Reconciliation Report must be certified by the Agency during the last quarter of the Calendar Year.

Once the ACA Reconciliation Report has been reviewed and all discrepancies have been updated (corrected), the Agency Benefits Administrator must certify the ACA data.

Certification is completed on the **ACA Data Entry** page. This process will include:

- Defining the Agency Contact
- Entering the total Full-Time and total employee counts for each Month of the Calendar Year
- Completing the Certification Statement

Menu > Benefits > Employer Information > ACA Data Entry

For more information and instructions on how to complete the ACA certification, refer to the Job Aid titled BN361_ACA Data Entry. This Job Aid is located on the Cardinal Website in **Job Aids** under [Learning](#).



ACA Reporting Process Flow

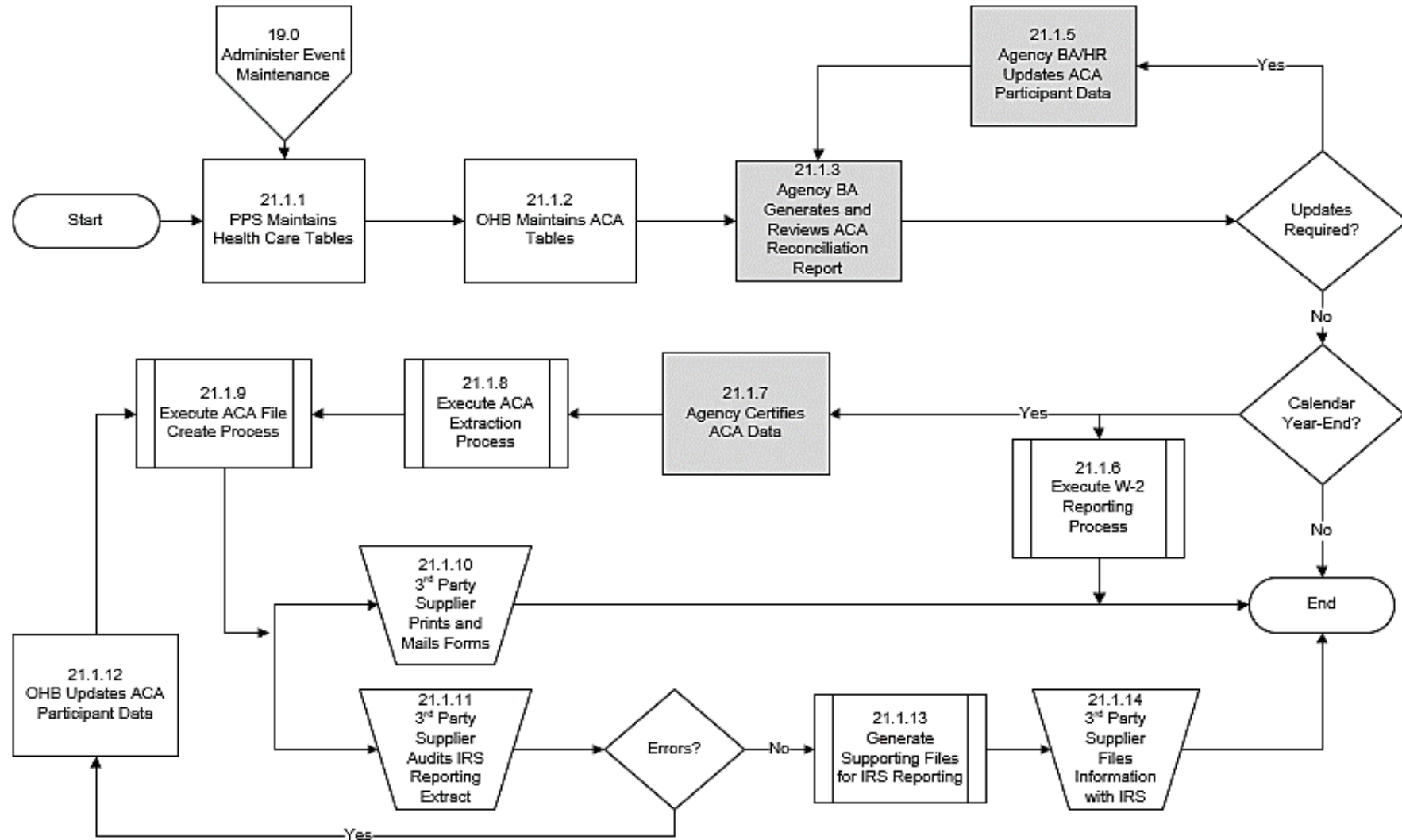

Note: Once Agency certification is complete, OHB, the 3rd Party Supplier(s), and the Cardinal PPS Team will complete the rest of the ACA Calendar Year-End processing.



Lesson Summary

9

ACA Administration

In this lesson, you learned

- Overview of ACA Administration Process Flow
- Overview of the Agency Responsibilities during ACA Reconciliation
- How to generate the ACA Reconciliation Report
- How to certify the ACA Data



Lesson

10

Retirement Plan Enrollments

This lesson covers the following topics:

- Deferred Compensation Process Overview
- Annuity Process Overview



Deferred Compensation Enrollment Steps

Cardinal stores employees' Deferred Compensation plan elections to maintain payroll deductions. VRS is the state Agency responsible for managing COVA's relationship with the Vendor. Enrollment is completed using the following steps:

- Participant (employee) enrolls on the Vendor website or via a form
- The Upload File process is run monthly to import the Vendor's Upload File into Cardinal. This upload will:
 - Evaluate the employee's eligibility for the cash match based upon their retirement enrollment
 - Automatically update the individual employee's Deferred Compensation supplement election on the **Savings Plan Table (Cardinal Base Benefits page)**



Deferred Compensation Enrollment Steps (continued)

- The Agency Benefits Administrator then runs the Defined Contribution Elections Upload Error Report which will identify any enrollments not successfully updated in Cardinal
- If an error from the Defined Contribution Elections Upload Error Report requires a manual fix, the Agency Benefits Administrator will create a manual Benefit Event (ELG BAS Action) to open the enrollment options and enroll the employee in the Deferred Compensation plan (Plan Type 49)

For more information and instructions on how to run this report, refer to the HCM Reports Catalogs. The HCM Reports Catalogs are located on the Cardinal Website in **Reports Catalogs** under [Resources](#).



Sample Defined Contributions Upload Error Report

 Report ID: RHR148	Commonwealth of Virginia	Run Date: 02/02/2024
	DEFINED CONTRIBUTION ELECTIONS UPLOAD ERROR REPORT	Run Time: 01:14 00

EFFECTIVE DATE - 01/01/2024
 FROM DATE: 01/01/2024 TO DATE: 01/31/2024

Page No. 1 of 3

<u>CMP</u>	<u>EMPLID</u>	<u>NAME</u>	<u>BEN PLAN</u>	<u>COVG ELCT</u>	<u>PRE-TAX AMOUNT</u>	<u>POST-TAX AMOUNT</u>	<u>EFF DATE</u>	<u>PLN TYP</u>	<u>MNTH-PAYS</u>	<u>ERR TYP</u>	<u>ERROR MSG</u>
BUC				E	20.00	0.00	01/01/2024	49		I	ERROR: Employee Status Terminated
BUC				E	20.00	0.00	01/01/2024	49		I	The Company associated with the Employee in the file is different from PS_JOB
CBR			457P24	W	0.00	0.00	01/01/2024	49	12-24	N	Enrollment received for 0.00 Deferred Comp Deduction, but employee not currently enrolled in Cardinal.
DJJ			457P24	E	50.00	0.00	01/01/2024	49	12-24	N	Processing Note: Loaded Using SSN. EMPLID not on vendor file.
DJJ				W	0.00	0.00	01/01/2024	49		I	The Company associated with the Employee in the file is different from PS_JOB
DJJ				W	0.00	0.00	01/01/2024	49		I	ERROR: Employee Status Terminated
DJJ				W	0.00	0.00	01/01/2024	49		I	The Company associated with the Employee in the file is different from PS_JOB
DJJ				W	0.00	0.00	01/01/2024	49		I	ERROR: Employee Status Terminated
DJJ				E	20.00	0.00	01/01/2024	49		I	ERROR: Employee Status Terminated
DJJ				E	20.00	0.00	01/01/2024	49		I	The Company associated with the Employee in the file is different from PS_JOB



Annuity Plans Enrollment Steps

Annuity plans are administered by the Fringe Benefits Management Company (FBMC). Cardinal stores employees' annuity plan elections to maintain payroll deductions. Enrollment is completed using the following steps:

- Participant enrolls via provided methods
- FBMC submits an upload file Monthly to Cardinal to process changes (the SPO Calendar can be used to identify the specific day each Month)
- The Load FBMC Upload File process is then run to import the FBMC Upload File into Cardinal. This upload will:
 - Evaluate the employee's eligibility for the cash match based upon their retirement enrollment
 - Automatically update the individual employee's Deferred Compensation supplement election on the **Savings Plan Table (Cardinal Base Benefits page)**



Annuity Plans Enrollment Steps (continued)

- The Agency Benefits Administrator then runs the FBMC Upload Error Report which will identify any enrollments not successfully updated in Cardinal
- If an error from the FBMC Upload Error Report requires a manual fix, the Agency Benefits Administrator will create a manual Benefit Event (ELG BAS Action) on the **Review BAS Activity** page to open the enrollment options and enroll the employee in the Annuity plan (Plan Type 46)

For more information and instructions on how to run this report, refer to the HCM Reports Catalogs. The HCM Reports Catalogs are located on the Cardinal Website in **Reports Catalogs** under [Resources](#).



Sample FBMC Upload Error Report

COMMONWEALTH OF VIRGINIA		FBMC UPLOAD ERROR REPORT										Run Date: 03/25/2021	
Report ID: RHR147												Run Time: 11:44 00	
FILE PROCESSED DATE FROM 25-MAR-2021 TO 25-MAR-2021												Page No. 1 of 3	
CMP	EMPLID	LAST NAME	EFF DATE	POST-TAX GEN DED	FEMC FEE	DOA FEE	403B TYPE	403B AMOUNT	CATCHUP AMOUNT	TOTAL AMOUNT	ROTH TYPE	ROTH POST TAX AMT	ERROR MSG
				20.00	2.00	0.15	\$	20.25	0.00	20.25	%	5.00	FEMC Agency has no matching Company in Cardinal
				20.00	2.00	0.15	\$	20.25	0.00	20.25	%	5.00	FEMC Agency 00100 does not use Cardinal Payroll.
				20.00	2.00	0.15	\$	20.25	0.00	20.25	%	5.00	Benefit Plan Error - Employee either didn't have benefit eligibility or missing benefit mapping in Cardinal
				20.00	2.00	0.15	\$	20.25	0.00	20.25	%	5.00	ERROR - Election not processed; No Match on EMPLID or SSN, research and update manually
				20.00	2.00	0.15	\$	20.25	0.00	20.25	%	5.00	Invalid company for the Employee in Cardinal . Please Research and Manually Update.
				20.00	2.00	0.15	\$	20.25	0.00	20.25	%	5.00	SSN on file does not match SSN for EMPLID.
CCC			04/01/2020	10.00	0.00	0.00	%	0.00	0.00	0.00	%	0.00	Employee HR status is inactive in cardinal.
COF			11/10/2019	0.00	0.00	0.00	%	0.00	0.00	0.00	\$	110.00	403b ERROR-Election exists for same EPFDT and amount, research and manual update if necessary.
CVA			04/01/2020	0.00	0.00	0.00	%	0.00	0.00	0.00	%	0.00	MISC Ins. Warning-Added End Date to MISC Ins, Deduction Amt: 0.00.
DMV			04/01/2020	0.00	0.00	0.00	%	0.00	0.00	0.00	%	0.00	MISC Ins. Errorenrollment exists for employee with a date greater than the new election, manually update if needed.
DOA			04/01/2020	10.00	0.00	0.00	%	0.00	0.00	0.00	%	0.00	SSN on file does not match SSN for EMPLID.
DSP			04/01/2020	0.00	0.00	0.00	%	0.00	0.00	0.00	%	0.00	Election not processed, Both EMPLID and SSN not found on incoming file.
DSP			04/01/2020	10.00	1.35	0.15	%	0.00	0.00	0.00	%	0.00	Election received for employee who is currently on Leave of Absence /Suspension
DSP			04/01/2020	20.00	2.00	0.15	%	0.00	0.00	0.00	%	0.00	Invalid company for the Employee in Cardinal . Please Research and Manually Update.
JSR			04/01/2020	0.00	0.00	0.00	\$	0.00	0.00	0.00	\$	0.00	403b ERROR-Election exists for same EPFDT and



Lesson Summary

10

Retirement Plan Enrollments

In this lesson, you learned

- Overview of the Deferred Compensation Process
- Overview of the Annuity Process



Lesson

11

Processing Retirements Overview

This lesson covers the following topics:

- Retirement Overview
- ORP Retirement Overview
- VRS Retirement Overview
- VRS Billing Reconciliation Overview



Retirement Overview

There are two ways in which employees can be processed for retirement; Optional Retirement Plan (ORP) or through the Virginia Retirement System (VRS).

Note: Not all Agencies will process ORP Retirements.



ORP Retirements



ORP Retirement Overview

If the Agency processes ORP Retirements, the Agency will have access to the ORP Retirement Position. There are actions that must be completed by both an Agency HR Administrator and an Agency BN Administrator. The specific actions required will be based on whether the employee is eligible for Medicare at the time of retirement.

Medicare Eligibility:

- Age: Over the age of 65
- Health: Health Condition that makes the individual eligible for Medicare prior to the age of 65



ORP Retirement Overview (Not Medicare Eligible)

Action	Additional Comments	Responsible Party
Retire the employee	Use an Action of “Retirement” and an Action Reason of “Retirement – ORP”. The effective date (one day after last day worked) of this transaction will be used as the effective date for the Hire action.	HR Administrator
Hire the Employee into the ORP Retirement Position	Use an Action of “Hire” and an Action Reason of “Hir ORP Ret”. This will trigger a Job Change Benefit Event.	HR Administrator
Enroll the Employee (and dependents) in a Non-Medicare Medical Plan	This process is performed on the On-Demand Event Maintenance page after the Hire transaction is completed by HR and the Benefits Administration process has run.	BN Administrator

For more information and instructions on how to complete ORP Retirements, refer to the Job Aid titled BN361_ORP Retiree Guide. This Job Aid is located on the Cardinal Website in **Job Aids** under [Learning](#).



ORP Retirement Overview (Medicare Eligible)

Action	Additional Comments	Responsible Party
Retire the employee	Use an Action of “Retirement” and an Action Reason of “Retirement – ORP”. The effective date (one day after last day worked) of this transaction will be used as the effective date for the Hire action.	HR Administrator
Hire the Employee into the ORP Retirement Position	Use an Action of “Hire” and an Action Reason of “Hir ORP Ret”. This will trigger a Job Change Benefit Event.	HR Administrator
Update the ACA Employee Eligibility page for the employee	Use the effective date for the Hire action and select the ACA Eligibility Status of “Excluded”.	BN Administrator
Enroll the Employee in the Medicare Medical Plan	This process is performed on the On-Demand Event Maintenance page after the Hire transaction is completed by HR and the Benefits Administration process has run.	BN Administrator



ORP Retirement Overview (Medicare Eligible) (continued)

If the retiree's Spouse is not Medicare eligible, the following steps must also be performed:

Action	Additional Comments	Responsible Party
Hire the Spouse as an employee (ORP Retirement Position) and link the Spouse to the Retiree	Use an Action of "Hire" and an Action Reason of "Hir ORP Ret". This will trigger a Job Change Benefit Event. The Spouse is added into a Non-Payroll Pay Group.	HR Administrator
Enroll the Spouse (and any other Non-Medicare eligible dependents) in a Non-Medicare Medical Plan	This process is performed on the On-Demand Event Maintenance page after the Hire transaction is completed by HR and the Benefits Administration process has run.	BN Administrator

For more information and instructions on how to complete ORP Retirements, refer to the Job Aid titled BN361_ORP Retiree Guide. This Job Aid is located on the Cardinal Website in **Job Aids** under [Learning](#).



VRS Retirements



VRS Retirement Overview

All Non-Locality Agencies can process VRS Retirements. There are actions that must be completed by both VRS and an Agency BN Administrator. The specific actions required will be based on whether the employee is eligible for Medicare at the time of retirement.

- Participants manage their enrollments through the [myVRS](#) portal
- VRS utilizes VNAV to manage all VRS Retirement Job Records
- The VRS Job Record can be created up to 40 days prior to the employee's official retirement date
- Participants will also need to submit a State Health Benefits Enrollment form for Retirees, Survivors, and LTD Participants in the following cases:
 - Employee is Medicare eligible but has dependents that are not Medicare eligible as this will require a split contract
 - If the employee is declining/canceling COVA Retiree/LTD healthcare coverage



VRS Retirement Process Flow

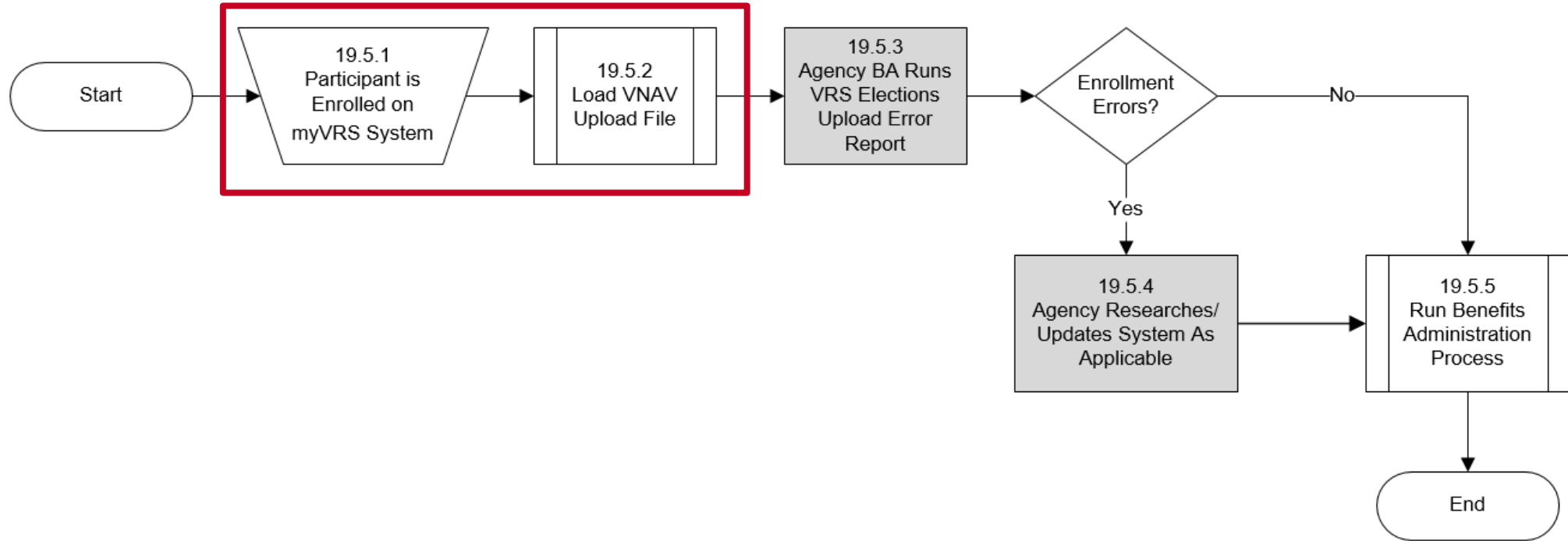



Enrollment and VNAV Upload to Cardinal

Enrollment:

The participant enrolls through the [myVRS](#) portal. The agency should encourage the employee to make their selection as soon as possible and explain that delayed enrollment will result in retroactive collection of contributions.

VNAV Upload:

The VNAV Upload File is imported into Cardinal daily by the Cardinal PPS Team. This upload will complete the following for each new enrolled employee:

- Updates the employee's Job Record with the respective Action and Action Reason defined in the upload file
- Stores the Eligibility Configuration field values for Elig Config Field 1 (Retirement Plan Code) and Elig Config Field 6 (VRS Organization Code)



Enrollment and VNAV Upload to Cardinal (continued)

Annual Benefits Base Rate USD ACA Eligibility Details

Benefits Administration Eligibility ⓘ

BAS Group ID	SN2	HCM Release 2 Snapshot		Elig Fld 3	Y
Elig Fld 1	VSY0000	Elig Fld 2	140001000	Elig Fld 6	30140
Elig Fld 4		Elig Fld 5		Elig Fld 9	SF-GB
Elig Fld 7		Elig Fld 8	12-24		

Retirement Plan Code → Elig Fld 1 VSY0000

Elig Fld 6 30140 ← VRS Organization Code

Benefit Program Participation Details ⓘ

Effective Date 08/29/2016 Currency Code USD
Benefit Program SAL Salaried Employee Benefit Pgm

Job Data Employment Data Earnings Distribution Benefits Program Participation

For more information about the Eligibility Configuration fields, refer to the Job Aid titled BN361_Overview of the Eligibility Configuration Fields. This Job Aid is located on the Cardinal Website in **Job Aids** under [Learning](#).



VRS Retirement Process Flow

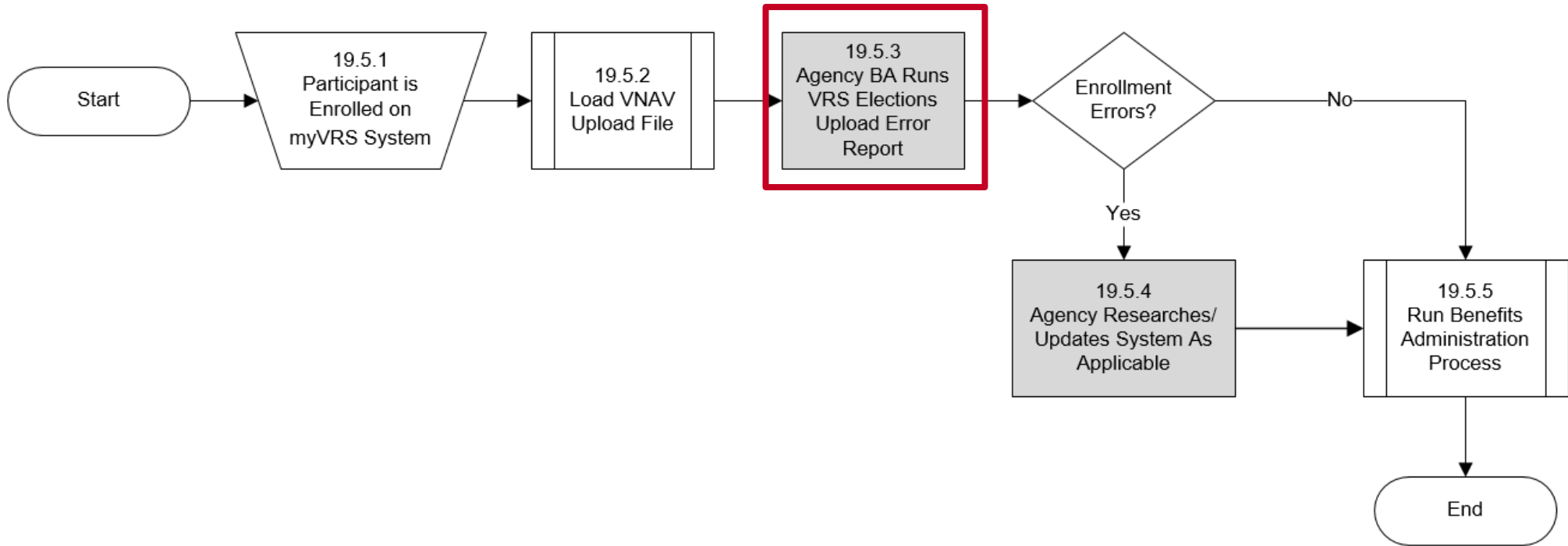

Note: For agencies supported by DHRM Shared Services, the steps in gray will be completed by DHRM, not the agency BA.



Running and Reviewing the VRS Elections Upload Error Report

Agency BN Administrators should run the VRS Elections Upload Error Report the day after the VNAV Upload File is imported into Cardinal. This is done in order to identify any enrollment errors.

NavBar > Menu > Benefits > Reports > VNAV Elections Upload Err Rpt

Some of the common errors include:

- Employee Record not found
- Employee Terminated
- Wage Employee that is not eligible for VRS Retirement

For more information and instructions on how to run this report, refer to the HCM Reports Catalogs. The HCM Reports Catalogs are located on the Cardinal Website in **Reports Catalogs** under [Resources](#).



Demonstration

In this demonstration, the Instructor will demonstrate the following:

- Running the VNAV Elections Upload Error Report



Sample VNAV Elections Upload Error Report



Report ID: RHR149

Commonwealth of Virginia

VNAV ELECTIONS UPLOAD ERROR REPORT

Run Date: 12/18/2020

Run Time: 01:52 00

Company: BCC-Bland Correctional Center
From Date: 12/18/2020
To Date: 12/18/2020

Page No. 2 of 5

Transaction Errors. Online Entry Required

Empl	Company	Department	Hire Date	Status	Plan	EFFDT	VOL	PSBB	PSBB	PSBB	PSBB			
<u>Emplid</u>	<u>Rcd</u>	<u>Name</u>	<u>Company</u>	<u>Department</u>	<u>Hire Date</u>	<u>Status</u>	<u>Plan</u>	<u>EFFDT</u>	<u>PCT</u>	<u>VSDP</u>	<u>CODE</u>	<u>AMNT</u>	<u>ADJ</u>	<u>ADJ AMT</u>
00900006900	0	T02BN1922,Employee 20 RER ICMA-RC	BCC	100	10/15/2019	A	12/01/2020	0.00%				0.00		0.00

Error Message

File has missing VRS Plan Code

Plan Type	Coverage	Deduction	Participant	Election	Benefit Before Tax	Before Tax %	After Tax	After Tax %	
<u>Plan Type</u>	<u>Begin Date</u>	<u>Begin Date</u>	<u>Election</u>	<u>Date</u>	<u>Plan</u>	<u>Flat Amount</u>	<u>of Earnings</u>	<u>Flat Amount</u>	<u>of Earnings</u>
-						0.00	0.00%	0.00	0.00%

Empl	Company	Department	Hire Date	Status	Plan	EFFDT	VOL	PSBB	PSBB	PSBB	PSBB			
<u>Emplid</u>	<u>Rcd</u>	<u>Name</u>	<u>Company</u>	<u>Department</u>	<u>Hire Date</u>	<u>Status</u>	<u>Plan</u>	<u>EFFDT</u>	<u>PCT</u>	<u>VSDP</u>	<u>CODE</u>	<u>AMNT</u>	<u>ADJ</u>	<u>ADJ AMT</u>
00923561300	0	T02BN1929,Employee 07 RER_VNAV	BCC	100	08/25/2020	A	4W	11/16/2020	1.00%	Y		0.00		0.00
00923561300	0	T02BN1929,Employee 07 RER_VNAV	BCC	100	08/25/2020	A	HB	11/16/2020	0.00%	Y		0.00		0.00

Error Message

Election was rejected because the current record in Cardinal has a newer EFFDT than the transaction on the file.



VRS Retirement Process Flow

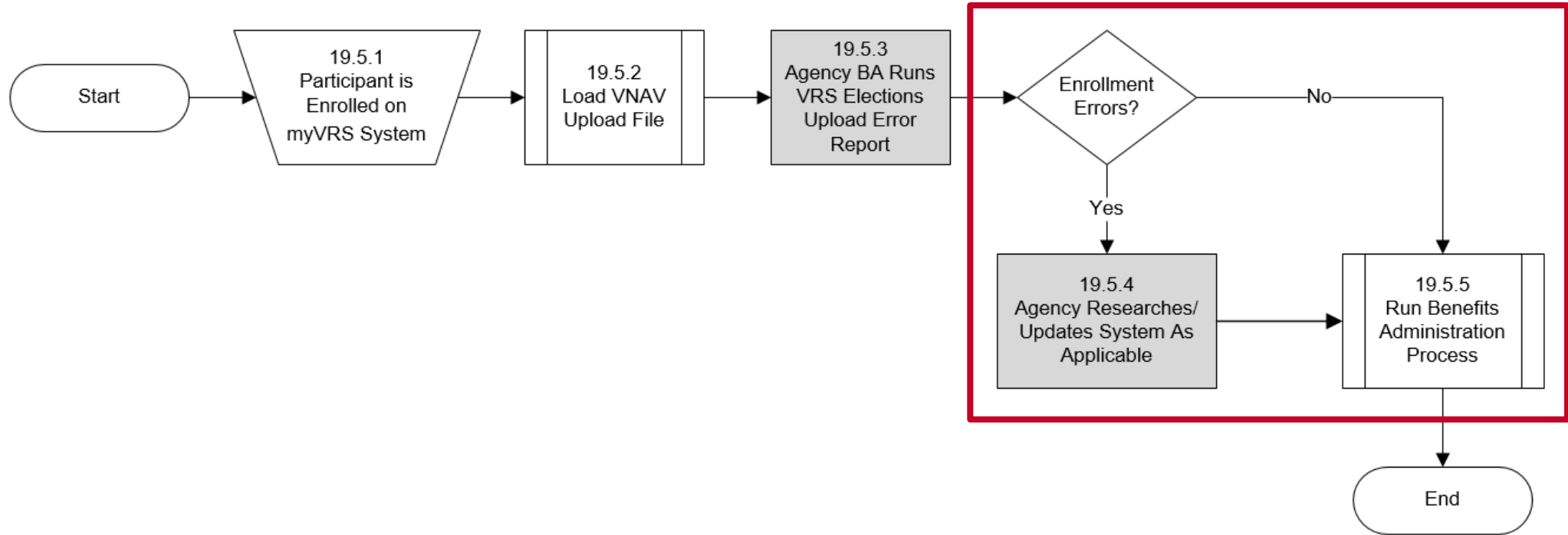

Note: For agencies supported by DHRM Shared Services, the steps in gray will be completed by DHRM, not the agency BA.



Enrollment Error Troubleshooting

If any errors are identified on the VNAV Elections Upload Error Report, an Agency HR and BN Administrators must work together to resolve the errors.

The appropriate resolution will vary based on the specific error and could include making updates to the Eligibility Configuration fields for the employee to trigger a Benefit Event and completing the applicable Benefit enrollments.

For more information about resolving upload errors, refer to the Job Aid titled BN361_Benefit Upload Error Reports Troubleshooting. This Job Aid is located on the Cardinal Website in **Job Aids** under [Learning](#).



Benefits Administration Process

Once all errors are resolved, the Benefits Administration Process will:

- Evaluate employee eligibility
- Enroll the employee in the correct retirement plan

For more information and specific instructions on how to process VRS Retirements, refer to the Job Aid titled VRS Retirement and LTD Processes for HR and BN Admins. This Job Aid is located on the Cardinal Website in **Job Aids** under [Learning](#).



VRS Billing Reconciliation



VRS Billing Reconciliation Overview

The VRS Billing Reconciliation program runs monthly to compare the VRS retirement billing file with retirement deductions processed through Cardinal Payroll. The reconciliation identifies differences between the expected retirement contribution amounts according to the employee retirement plan enrollments in VNAV and the retirement contributions actually collected through the combination of employee and employer deductions in Cardinal Payroll.

Examples of discrepancies that could require review and correction include:

- VRS billing changes to the direct bill status
- Retirees turning the age of 65 and changing their Benefits from COVA Care to Medicare
- Dependents aging out (going over the age of 26)

Resolution to identified discrepancies could include actions to be taken by Agency HR, BN, and PY Administrators.



VRS Billing Reconciliation Process Flow

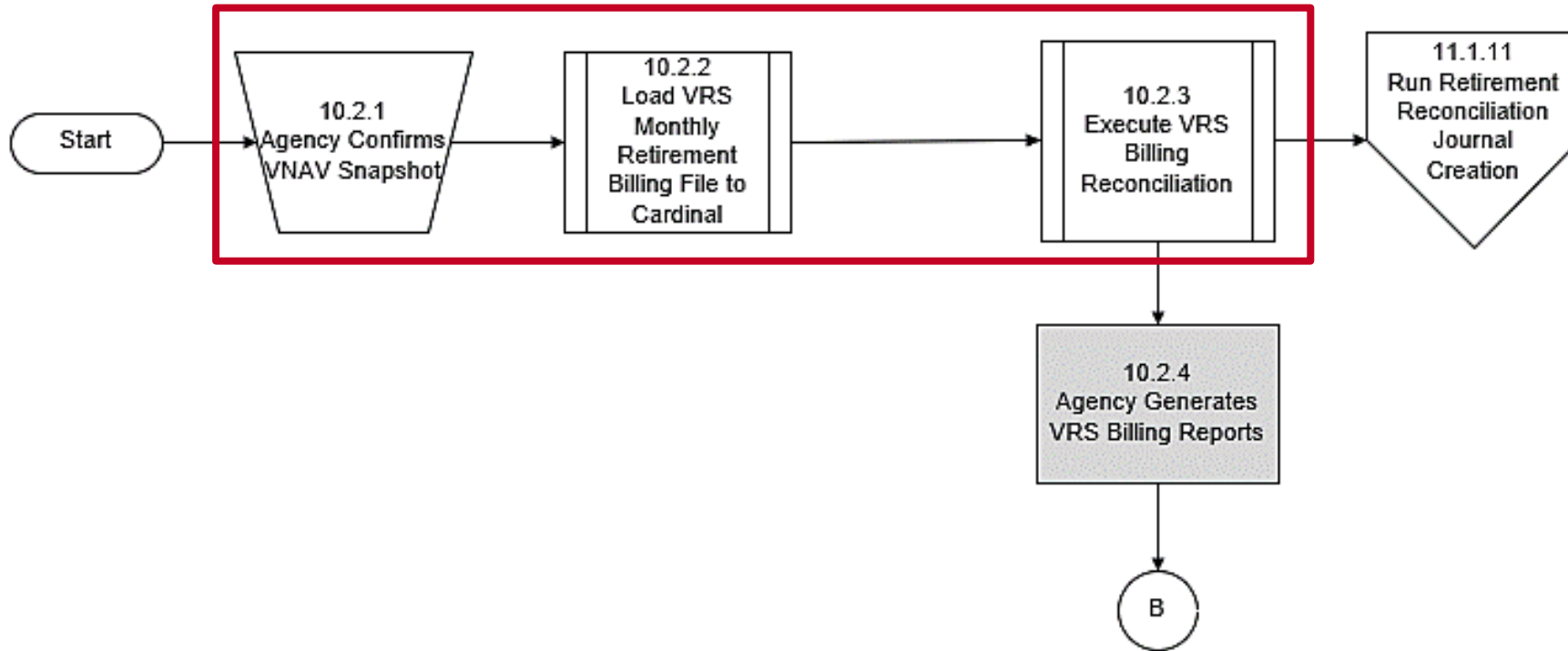



VNAV to Cardinal Interface

The VNAV snapshot is interfaced to Cardinal at the beginning of each Month.

Once the Agency confirms the snapshot, the Cardinal PPS Team completes the following:

- Load the VRS Monthly Retirement Billing File to Cardinal
- Run the VRS Billing Reconciliation Program. The VRS Billing Reconciliation Program includes retroactive adjustments for previous months as corrections are made



VRS Billing Reconciliation Process Flow

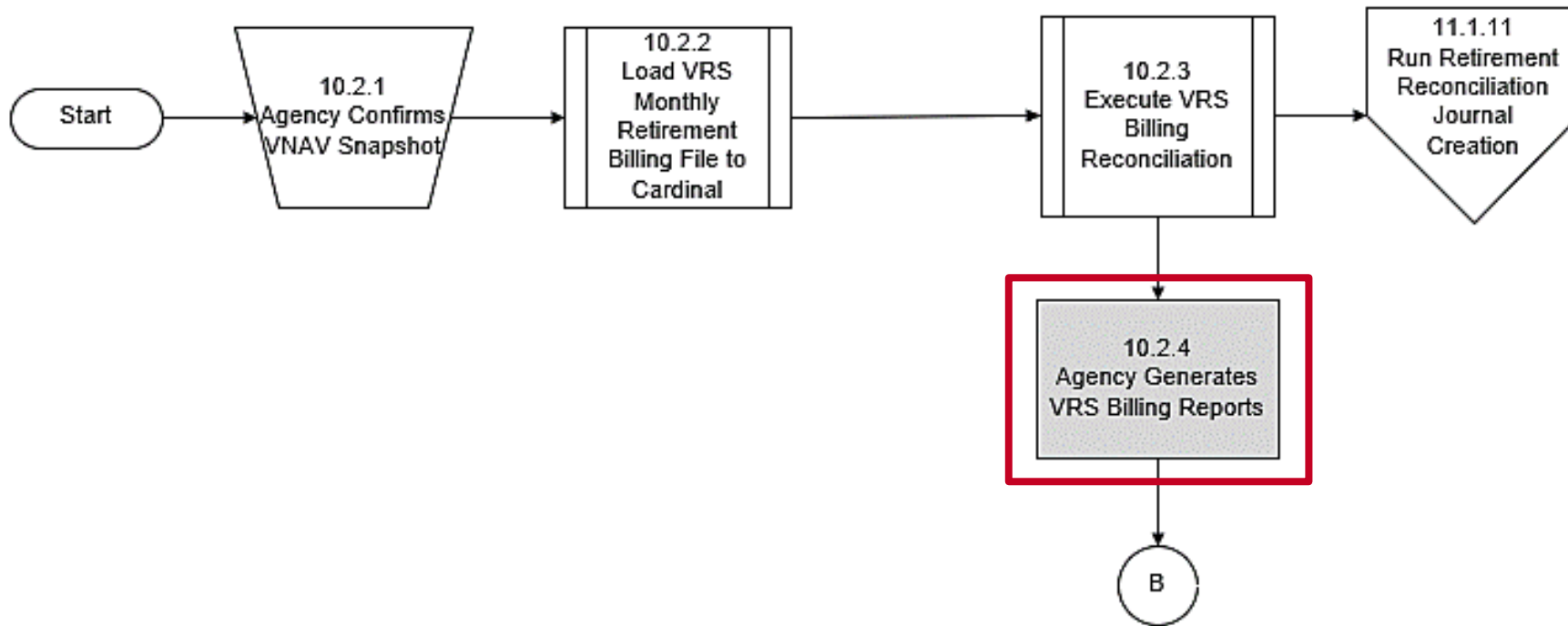

Note: For agencies supported by DHRM Shared Services, the steps in gray will be completed by DHRM, not the agency BA.



VRS Billing Reports and Queries

Once the VRS Billing Reconciliation Program is run, there are two reports and one query that Agency PY Administrators and SPO will run to complete the reconciliation.

VRS Billing Detail Query:

- Lists the transactions (grouped by Retirement Plan) from the VRS Billing Upload File
- Lists the total contribution amounts for each transaction and each Retirement Plan

NavBar > Menu > Reporting Tools > Query > Query Viewer > V_VRS_BILLING REPORT

For more information and instructions on how to run this query, refer to the HCM Reports Catalogs. The HCM Reports Catalogs are located on the Cardinal Website in **Reports Catalogs** under [Resources](#).



Sample VRS Billing Details Query

V_VRS_BILLING_REPORT - VRS Billing Detail Report

Year

Month (Leave Blank for All)

Emplid (Leave Blank for All)

Download results in : [Excel SpreadSheet](#) [CSV Text File](#) [XML File](#) (8 kb)

View All

First 1-24 of 24 Last

Row	EMPLID	Name	COMPANY	BUSINESS_UNIT	DEPTID	EMPL_STATUS	MONTH	YEAR	PLAN_CODE	RETIRE_EE_AMT	RETIRE_ER_AM	PPS_TAX	PPS_AMT	GRP_LIFE_AMT	LTD_AMT	HIC_AMT
1			CCV	11300	10000	A	1	2020	HJ	586.09	4892.34	N	0.00	191.95	0.00	171.45
2			CCV	11300	10000	A	2	2020	HJ	586.09	4892.34	N	0.00	191.95	0.00	171.44
3			CCV	11300	10000	A	2	2020	JN	732.60	5038.88	N	0.00	191.94	0.00	171.44
4			CCV	11300	10000	A	1	2020	JN	732.60	5038.88	N	0.00	191.94	0.00	171.44
5			DEL	10100	2202	A	1	2020	HB	175.01	504.00	N	0.00	57.32	27.12	51.18
6			DEL	10100	2201	A	1	2020	VN	73.50	198.74	N	0.00	19.26	9.11	17.20
7			DEL	10100	2201	A	2	2020	VN	73.50	198.74	N	0.00	19.26	9.11	17.20
8			DEL	10100	2201	A	1	2020	VN	77.08	208.43	N	0.00	20.20	0.00	18.04
9			DEL	10100	2201	A	2	2020	VN	77.08	208.43	N	0.00	20.20	0.00	18.04
10			DEL	10100	2202	A	1	2020	XB	219.99	594.85	Y	0.00	57.64	27.28	51.48
11			DEL	10100	2202	A	2	2020	XB	219.99	594.85	Y	0.00	57.64	27.28	51.48
12			DOT	50100	10003	A	2	2020	VS	166.66	450.66	N	0.00	43.67	20.67	39.00
13			DOT	50100	10003	A	1	2020	VS	166.66	450.66	N	0.00	43.66	20.66	39.00
14			DSP	15600	232201	A	1	2020	LN	379.24	819.52	N	0.00	49.68	23.52	44.38
15			DSP	15600	232201	A	2	2020	LN	189.62	819.52	N	0.00	49.68	23.52	44.38
16			DSP	15600	271001	A	2	2020	SN	126.20	1255.94	Y	252.40	56.66	31.30	50.62
17			DSP	15600	271001	A	1	2020	SN	126.20	1255.94	Y	252.40	66.12	31.30	59.06
18			NSU	21300	04004	A	1	2020	HB	302.00	945.26	N	0.00	98.90	46.81	88.34
19			NSU	21300	04004	A	2	2020	HB	302.00	945.26	N	0.00	98.90	46.81	88.34
20			NSU	21300	04019	A	1	2020	HB	257.50	645.04	N	0.00	84.34	39.92	75.32
21			NSU	21300	50006	A	2	2020	LS	262.01	0.00	N	0.00	68.65	0.00	61.31
22			NSU	21300	50006	A	1	2020	LS	262.00	0.00	N	0.00	68.64	0.00	61.30
23			NSU	21300	04022	A	1	2020	VN	308.33	833.73	N	0.00	80.78	38.23	72.14
24			NSU	21300	04022	A	2	2020	VN	308.33	833.73	N	0.00	80.78	38.23	72.15



VRS Billing Reports and Queries (continued)

VRS Billing Summary Report:

- Lists the total retirement costs in VNAV
- Lists the contributions deducted in Cardinal Payroll
- Used to identify and review the differences between the retirement costs in VNAV and the contribution deducted in Cardinal Payroll

Menu > Benefits > Reports > VRS Billing Summary

For more information and instructions on how to run this report, refer to the HCM Reports Catalogs. The HCM Reports Catalogs are located on the Cardinal Website in **Reports Catalogs** under [Resources](#).



Sample VRS Billing Summary Report

 Report ID: RHR079	Commonwealth of Virginia VRS BILLING SUMMARY REPORT	Run Date: 02/25/2021 Run Time: 07:07 00
--	---	--

Page No. 1 of 1

Billing Month :January 2020

BU	VRS Org Code	Benefit Plan Type	GL Acct EE	VRS Bill Amt EE	Payroll Amt EE	GL Adjstmnt EE	Rounding Non Billed EE	GL Acct ER	VRS Bill Amt ER	Payroll Amt ER	GL Adjstmnt ER	Rounding Non Billed ER
10100	101	Employee Retirement DB	22051448	0.00	0.00	0.00	0.00	5011110	0.00	0.00	0.00	0.00
		Group Term Life		0.00	0.00	0.00	0.00	5011140	0.00	12.84	0.00	-12.84
		Hybrid Retirement	22051448	0.00	39.20	0.00	-39.20	5011110	0.00	122.70	0.00	-122.70
		Retiree Health Credit		0.00	0.00	0.00	0.00	5011160	0.00	11.47	0.00	-11.47
		VSDP LTD		0.00	0.00	0.00	0.00	5011170	0.00	6.08	0.00	-6.08
	Org Code Total			0.00	39.20	0.00	-39.20		0.00	153.09	0.00	-153.09
	30101	Employee Retirement DB	22051424	370.57	23,827.46	0.00	-23,456.89	5011110	1,002.02	78,329.93	0.00	-77,327.91
		Employee Retirement DB	22051448	0.00	0.00	0.00	0.00	5011110	0.00	0.00	0.00	0.00
		General Deduction	22051411	0.00	0.00	0.00	0.00		0.00	0.00	0.00	0.00
		Group Term Life		0.00	0.00	0.00	0.00	5011140	154.42	11,902.74	0.00	-11,748.32
		Hybrid Retirement	22051448	175.01	14,337.32	0.00	-14,162.31	5011110	504.00	44,828.67	0.00	-44,324.67
		Retiree Health Credit		0.00	0.00	0.00	0.00	5011160	137.90	10,630.45	0.00	-10,492.55
		VSDP LTD		0.00	0.00	0.00	0.00	5011170	63.51	3,009.33	0.00	-2,945.82
	Org Code Total			545.58	38,164.78	0.00	-37,619.20		1,861.85	148,701.12	0.00	-146,839.27
	XB101	Employee Retirement DB	22051424	0.00	129.69	0.00	-129.69	5011110	0.00	350.68	0.00	-350.68
		Group Term Life		0.00	0.00	0.00	0.00	5011140	0.00	33.98	0.00	-33.98
		Retiree Health Credit		0.00	0.00	0.00	0.00	5011160	0.00	30.35	0.00	-30.35
		VSDP LTD		0.00	0.00	0.00	0.00	5011170	0.00	16.08	0.00	-16.08
	Org Code Total			0.00	129.69	0.00	-129.69		0.00	431.09	0.00	-431.09
	Plan Type Total											
		Employee Retirement DB		370.57	23,957.15	0.00	-23,586.58		1,002.02	78,680.61	0.00	-77,678.59
		Hybrid Retirement		175.01	14,376.52	0.00	-14,201.51		504.00	44,951.37	0.00	-44,447.37
		VSDP LTD		0.00	0.00	0.00	0.00		63.51	3,031.49	0.00	-2,967.98
		Group Term Life		0.00	0.00	0.00	0.00		154.42	11,949.56	0.00	-11,795.14
		Retiree Health Credit		0.00	0.00	0.00	0.00		137.90	10,672.27	0.00	-10,534.37
	BU Total			545.58	38,333.67	0.00	-37,788.09		1,861.85	149,285.30	0.00	-147,423.45
	Grand Plan Type Total											
		Employee Retirement DB		370.57	23,957.15	0.00	-23,586.58		1,002.02	78,680.61	0.00	-77,678.59
		Hybrid Retirement		175.01	14,376.52	0.00	-14,201.51		504.00	44,951.37	0.00	-44,447.37
		VSDP LTD		0.00	0.00	0.00	0.00		63.51	3,031.49	0.00	-2,967.98
		Group Term Life		0.00	0.00	0.00	0.00		154.42	11,949.56	0.00	-11,795.14
		Retiree Health Credit		0.00	0.00	0.00	0.00		137.90	10,672.27	0.00	-10,534.37
	Grand Total			545.58	38,333.67	0.00	-37,788.09		1,861.85	149,285.30	0.00	-147,423.45



VRS Billing Reports and Queries (continued.)

VRS Billing Exceptions Report:

- Lists the variances between the retirement costs in VNAV and the retirement contributions in Cardinal Payroll

Menu > Benefits > Reports > VRS Billing Exceptions

For more information and instructions on how to run these reports, refer to the HCM Reports Catalogs. The HCM Reports Catalogs are located on the Cardinal Website in **Reports Catalogs** under [Resources](#).



Sample VRS Billing Exceptions Report



Commonwealth of Virginia
VRS BILLING EXCEPTIONS REPORT

Run Date: 05/25/2021
Run Time: 03:09 00

Page No. 1 of 3

Business Unit: 50100 - VA Dept of Transportation

Current Year: 2020

POSTED

Current Month: JAN

<u>EMPLID</u>	<u>Name</u>	<u>Pay Status</u>	<u>Dedcd</u>	<u>Benefit Plan</u>	<u>EE VRS Bill</u>	<u>EE Payroll Deduction</u>	<u>EE Recon GL Adjustment</u>	<u>ER VRS Bill</u>	<u>ER Payroll Deduction</u>	<u>ER Recon GL Adjustment</u>
VRS ORG CODE: 30501										
Benefit Section: Employee Retirement DB										
		A	VRSRET	VRSMDB	0.00	141.13	141.13	0.00	381.60	381.60
		A	VRSRET	VRSMDB	0.00	114.59	114.59	0.00	309.86	309.86
		A	VRSRET	VRSMDB	0.00	1,164.46	1,164.46	0.00	3,148.71	3,148.71
		A	VRSRET	VRSMDB	0.00	285.74	285.74	0.00	772.64	772.64
		A	VRSRET	VRSMDB	0.00	666.67	666.67	0.00	1,802.67	1,802.67
		A	VRSRET	VRSMDB	0.00	811.74	811.74	0.00	2,194.95	2,194.95
		P	VRSRET	VRSMDB	0.00	531.90	531.90	0.00	1,438.27	1,438.27
		P	VRSRET	VRSMDB	0.00	544.78	544.78	0.00	1,473.09	1,473.09
		A	VRSRET	VRSMDB	0.00	106.18	106.18	0.00	287.10	287.10
		P	VRSRET	VRSMDB	0.00	633.88	633.88	0.00	1,714.02	1,714.02
		P	VRSRET	VRSMDB	0.00	704.36	704.36	0.00	1,904.58	1,904.58
		A	VRSRET	VRSMDB	0.00	145.48	145.48	0.00	393.38	393.38
		A	VRSRET	VRSMDB	0.00	970.26	970.26	0.00	2,623.56	2,623.56
		A	VRSRET	VRSMDB	0.00	880.26	880.26	0.00	2,380.24	2,380.24
		P	VRSRET	VRSMDB	0.00	492.15	492.15	0.00	1,330.77	1,330.77
		P	VRSRET	VRSMDB	0.00	446.28	446.28	0.00	1,206.75	1,206.75
		P	VRSRET	VRSMDB	0.00	546.78	546.78	0.00	1,478.49	1,478.49
		P	VRSRET	VRSMDB	0.00	433.68	433.68	0.00	1,172.66	1,172.66
		A	VRSRET	VRSMDB	0.00	130.11	130.11	0.00	351.81	351.81
		A	VRSRET	VRSMDB	0.00	103.04	103.04	0.00	278.62	278.62
		A	VRSRET	VRSMDB	0.00	99.56	99.56	0.00	269.21	269.21
		A	VRSRET	VRSMDB	166.66	0.00	-166.66	450.66	0.00	-450.66
		A	VRSRET	VRSMDB	0.00	155.57	155.57	0.00	420.66	420.66
Section Total					166.66	10,108.60	9,941.94	450.66	27,333.64	26,882.98
Benefit Section: Hybrid Retirement										
		A	HBDBER	HBDBER	0.00	104.65	104.65	0.00	327.55	327.55
Section Total					0.00	104.65	104.65	0.00	327.55	327.55
Benefit Section: Group Term Life										
		A	GRPLFR	GTLR	0.00	0.00	0.00	0.00	36.97	36.97
		A	GRPLFR	GTLR	0.00	0.00	0.00	0.00	30.02	30.02
		A	GRPLFR	GTLR	0.00	0.00	0.00	0.00	305.09	305.09



VRS Billing Reconciliation Process Flow (cont'd)

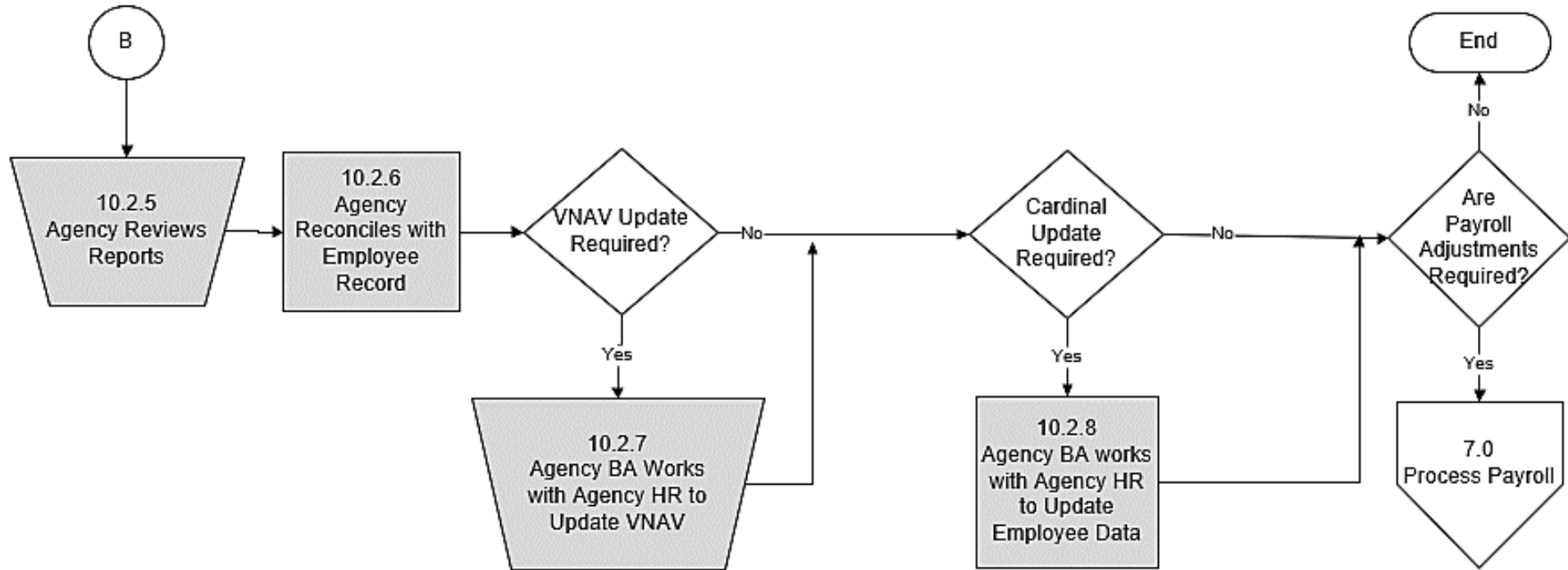

Note: For agencies supported by DHRM Shared Services, the steps in gray will be completed by DHRM, not the agency BA.



Review and Resolve Discrepancies

Agency PY Administrators are required to review the VRS Billing Reports and Queries.

As needed, Agency BN Administrators and HR Administrators will reconcile discrepancies against the associated Employee Record and:

- Make corrections to the Employee Record (HR Administrator)
- Make adjustments to the retiree's Benefits enrollments (BN Administrator)

As needed, Agency PY Administrators will work with HR Administrators to make corrections in VNAV as needed



Lesson Summary

11

Processing Retirements Overview

In this lesson, you learned

- Retirement Overview
- Overview of ORP Retirement
- Overview of VRS Retirement
- VRS Billing Reconciliation Overview



Course Summary

BN361

Cardinal Employee Benefit Enrollment and Maintenance

In this course, you learned

- An overview of Cardinal and Benefits
- The key concepts pertaining to Benefit Events and Programs
- An overview of Benefits navigation
- How to process New Hire Enrollments and Manual Benefit Events
- How to view other Employee and Dependent Benefits information
- How to administer COBRA
- How to complete Health Benefits Reconciliation
- How to administer ACA Administration
- An overview of Retirement Plan Enrollments
- An overview on how to process Retirements



Appendix

- Event Statuses
- Event Process Statuses
- Process Indicators
- Flowchart Key



Recommended Agency BA Reports Cadence

Report Name	Report Description	Cadence
Benefit Eligibility Audits Report	Lists employees and associated dependents approaching an age-related milestone that requires health care enrollment changes to remain compliant with policy. Report also identifies outstanding approvals for new dependents and disabled dependents that may need to be re-certified as disabled.	Daily
Benefit Event Status Report	This report lists all participants in a particular process status or set of status levels.	Daily
Premium Reward Audit Report	This report lists employees whose health premium reward enrollment or additional pay amount require updating to align with their current health benefit enrollment.	Weekly
COBRA Enrollment Report	This report lists all COBRA participants and their current elections, including coverage begin dates.	Weekly
Base Benefit Consistency Audit Report	This report displays data that has been entered into the benefit plan, employee data, dependent data, or enrollment data pages which does not appear to follow policy or regulations. The identified items could simply require corrections to some data elements or could require enrollment changes.	Monthly

Notes: For a full list of Benefit Reports and Queries refer to the **Cardinal HCM Reports Catalogs** which is located on the Cardinal website under Resources. Cadence is a suggestion, reports and queries can be run ad-hoc.



Event Statuses

An Event typically has 3 statuses: Open, Close, or Void. Events must have an Event Status of "Open" to be processed or reprocessed:

Event Status	Description
Open (O)	Cardinal will process on the next run of the Benefits Administration process. Only one event per Employee ID and Benefit Record Number combination can be opened at one time. The Event Status can be updated to Close automatically by Cardinal or manually on the Event Status Update page.
Close (C)	Not currently processed by the system. Closed events can be updated to Open, either automatically by Cardinal or manually on the Event Status Update page.
Void (V)	Has been backed out of the system and all related eligibility processing has been reversed. Use the Event Status Update page to change the Event Status to Void. Events with an Event Status of Void can be updated to Open or Close through the Event reprocessing steps.

Note: For further information on Event Statuses, refer to the Job Aid titled **BN361_Benefits Quick Reference Guide**. This Job Aid can be found on the Cardinal website in **Job Aids** under **Learning**.



Event Process Statuses

The Event Process Status indicates if a step has been completed and displays any processing errors for each completed step:

Process Status	Reason
Assign Benefit Program	
Assign None (AN)	Benefits Administration was unable to assign a benefit program. This could be a result of the Benefit Flag set to a terminated Employee Record.
Assign Error (AE)	Benefits Administration was unable to assign Benefit Program due to missing or incorrect information.
Assigned (AS)	Benefits Administration assigned a Benefit Program because a prior event is Open. It is possible the Open Event is appearing on the MSC Event Evaluation report.
Prepare Options	
Prepare Error (PE)	Error in preparation of options. The system has encountered an error. This could be a result of a missing ICI ABBR or a missing payroll calendar.
Prepared (PR)	Cardinal calculated eligible options, credits, rates, and proof requirements for the employee associated with the event, and current elections have been identified for proof, eligibility level, and default processing.
Notified (NT)	The employee accessed the Self-Service event but has not submitted elections.

Note: For further information on Process Statuses, refer to the Job Aid titled **BN361_Benefits Quick Reference Guide**. This Job Aid can be found on the Cardinal website in **Job Aids** under **Learning**.



Event Process Statuses (continued)

Process Status	Reason
Enter Elections	
Elections Error (EE)	Cardinal encountered an error while attempting to process the employee’s elections. This could be a result of the dependent effective dates, a mismatch between coverage code and listed dependents, or a missing pay calendar.
Re-Enter (RE)	BA reopened event
Elections Entered (ET)	BA (or the employee through ESS) entered new elections, which are ready for validation through the Benefits Administration Process.
Finalize Enrollments	
Finalized – Benefit Pgm None (FA)	Employee event has no program assignment or current elections. This could be a result of the Benefit Flag set to a terminated Empl Rcd. It could also be the result of an address change when employee is not active.
Finalized – Prepare None (FP)	Benefit Administration is acknowledging that the employee’s eligibility has not changed.
Finalized – Enrolled (FE)	Benefits Administration processing is complete for the employee event. All elections have been validated and loaded.

Note: For further information on Process Statuses, refer to the Job Aid titled **BN361_Benefits Quick Reference Guide**. This Job Aid can be found on the Cardinal website in **Job Aids** under **Learning**.



Process Indicators



The Process Indicator tells Cardinal how far back to open the event. Below are the descriptions for each Process Indicator:

Symbol	Name	Description
A	Assign Benefit Program	Cardinal is attempting to reprocess the participant to a “Prepared” status.
E	Elect Options	Cardinal is revalidating elections for the event and resetting the final process to a “Finalized – Enrolled” status.
N	Normal Processing	Cardinal is following standard processing procedures.
P	Prepare Options	Cardinal is re-evaluating the participant’s option eligibility and attempting to reprocess the participant to a “Prepared” status.
R	Re-Enter	Cardinal reopens the data entry page to enable election changes, resulting in a “Re-Enter” or “Elections Entered” status.
V	Void	Cardinal is voiding an event. When you void an event, it stays in the status that it was in when it was voided.

Note: For further information on Process Indicators, refer to the Job Aid titled **BN361_Benefits Quick Reference Guide**. This Job Aid can be found on the Cardinal website in **Job Aids** under **Learning**.

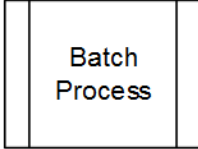
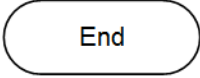
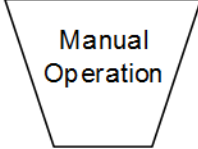
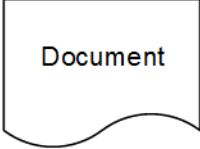
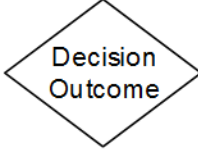
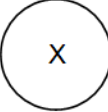
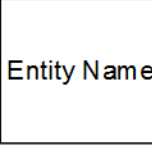
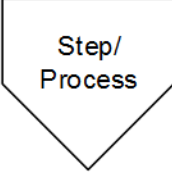

Flowchart Key

	Depicts a process step or interface.		Indicates point at which the process begins. Does not represent any activity.
	Specifies a batch process.		Indicates point at which the process ends. Does not represent any activity.
	Depicts a process step that is preformed manually.		Depicts a document of any kind, either electronic or hard copy.
	Defines the possible outcomes of a decision or analysis that took place in a step immediately preceding.		Indicates an on-page or intra process connector. Used to avoid complex overlapping connector lines or to continue a process on a subsequent page.
	Represents an entity (person, organization, etc.).		Connects steps between business processes.